

Product Catalog

RESALE - April 13th
2026



Your source for in-stock merchandise

NEW PRODUCTS!

Envelope Gift Bags - pg. 3

JCUT Twist - pg. 6

Jewelry Boxes - pg. 16

TABLE OF CONTENTS



PAPER

Envelope Gift Bags *NEW*	<u>3</u>
Serrated-Edge Shoppers	
Kraft + White.....	<u>4</u>
Black.....	<u>5</u>
Serrated-Edge Merchandise	
Kraft + White.....	<u>5</u>
JCUT Twist Handle *NEW*	<u>6</u>
JCUT Twill Handle	
Kraft.....	<u>7</u>
Kraft w/ Black	<u>8</u>
White.....	<u>9</u>
White w/ Black	<u>10</u>
Colors	<u>11</u>
Tint Totes	<u>12</u>

PAPER

Manhattans	<u>13</u>
Eurototes	
White.....	<u>14</u>
Colors	<u>15</u>

BOXES

Jewelry *NEW*	<u>16</u>
----------------------------	-----------

PLASTIC

Garment	
Stock.....	<u>17</u>
Custom	<u>18</u>
Luster-Glo.....	<u>19</u>
Frosty.....	<u>20</u>
T-Shirt.....	<u>20</u>
Hi-Density.....	<u>20</u>

CLOSEOUTS

Tint Totes	<u>20</u>
------------------	-----------

CUSTOM PRINTING

Print Types	<u>21</u>
Artwork Info.....	<u>22</u>
Proofing + Fees	<u>23</u>
Max. Print Area.....	<u>24</u>

SWATCHES

Ink-Printing.....	<u>26</u>
Hot-Stamping	
Metallic	<u>28</u>
Matte.....	<u>29</u>

All pricing is RESALE. Stock orders ship within 1-2 business days. Custom orders ship based on current printing lead times. All custom orders must have an approved proof before production begins. Orders scheduled for delivery more than three months ahead will be priced according to the rates at the time of shipment. Prices are subject to change without notice.

New Product

ENVELOPE GIFT BAGS



PRODUCT HIGHLIGHTS

- Top-flap closure
- Adhesive strip
- 180 GSM
- Matte laminated
- Ribbon already threaded on bag

BAG SIZE	CASE PACK	PLAIN	MAX. PRINT AREA
4½ x 2½ x 5½	100	\$104.00	3½ x 3
6½ x 3¼ x 7½	100	\$120.00	5 x 4½

HOT-STAMP PRICING

1-4 cases: \$200 LOT charge	5+ cases = 40¢ per bag
Plate Fee: \$170	

BAG + RIBBON COLOR COMBINATIONS

BAG COLOR	RIBBON COLOR				
	BLACK	GOLD	RED	SILVER	WHITE
Kraft		N/A	N/A	N/A	
White					N/A
Black			N/A		

Custom Print Information: [pgs. 21-29](#) • All pricing is RESALE • Prices subject to change without notice

PAPER SHOPPERS

Serrated-Edge • Kraft + White

FREE INK PLATE FOR NEW PRINTED ORDERS OF 500 BAGS OR MORE



PAPER SHOPPERS

SIZE	CASE PACK	KRAFT	WHITE	PRINTING MINIMUM
5¼ x 3½ x 8	250	\$105.00	\$115.50	500 2 cases
5¼ x 3½ x 12½ *	250	\$126.00	\$142.80	500 2 cases
6 x 3½ x 12½ *	250	\$149.10	\$155.40	500 2 cases
8 x 4¾ x 10¼	250	\$113.40	\$126.00	500 2 cases
10 x 5 x 10	250	\$123.90	\$136.50	500 2 cases
10 x 5 x 13	250	\$132.30	\$144.90	500 2 cases
10 x 7 x 12	250	\$136.50	\$147.00	500 2 cases
13 x 5 x 10	250	\$138.60	\$153.30	500 2 cases
13 x 7 x 13	250	\$147.10	\$176.40	500 2 cases
13 x 7 x 17	250	\$174.30	\$193.20	500 2 cases
15 x 10 x 15	200	\$153.30	\$189.00	400 2 cases
16 x 6 x 12	250	\$147.00	\$157.50	500 2 cases
16 x 6 x 19	200	\$147.00	\$168.00	400 2 cases
18 x 7 x 19	100	\$84.00	\$96.60	400 4 cases
24 x 7¼ x 18¾ ^	125	\$336.00	\$378.00	N/A

PRODUCT HIGHLIGHTS

Serrated-edge top
Twisted paper handles

PAPER WEIGHT

Kraft: 130 GSM
White: 120 GSM

DETAILS

* Includes cardboard bottom insert for bottle bags
^ Hot-Stamping not available on this size

PRINT SPECS

One-color per side
Two-sided printing available

INK-PRINTING

1st Side	2nd Side (Additional)
Minimum Quantity Order: 32¢ per bag	Minimum Quantity Order: 42¢ per bag
1000+ bags: 30¢ per bag	1000+ bags: 40¢ per bag

HOT-STAMPING

1st Side	2nd Side (Additional)
Minimum Quantity Order: 40¢ per bag	Minimum Quantity Order: 40¢ per bag
1000+ bags: 38¢ per bag	1000+ bags: 38¢ per bag

Sizes do not combine for custom-print pricing

Custom Print Information: [pgs. 21-29](#) • All pricing is RESALE • Prices subject to change without notice

Serrated-Edge • Black

PAPER SHOPPERS



PRODUCT HIGHLIGHTS

Serrated-edge top
Twisted paper handles
130 GSM

STAMP SPECS

Hot-Stamp only | One-color per side
Two-sided Hot-Stamping available

BLACK PAPER SHOPPERS

SIZE	CASE PACK	PER CASE	PRINTING MINIMUM
5¼ x 3½ x 8	250	\$142.80	500 2 cases
8 x 4¾ x 10¼	250	\$153.30	500 2 cases
10 x 5 x 13	250	\$178.50	500 2 cases
16 x 6 x 12	250	\$214.20	500 2 cases
16 x 6 x 19	200	\$226.80	400 2 cases

HOT-STAMPING

1st Side	2nd Side (Addtl')
Minimum Quantity Order: 40¢ per bag	Minimum Quantity Order: 40¢ per bag
1000+ bags: 38¢ per bag	1000+ bags: 38¢ per bag

Sizes do not combine for custom-print pricing

Serrated-Edge • Kraft + White

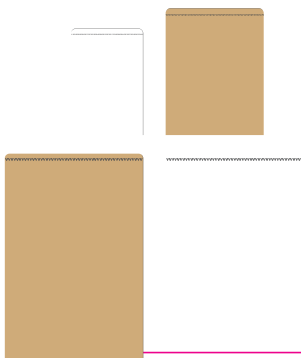

PRODUCT HIGHLIGHTS

Serrated-edge top
Flat • No handles
One-side print only
130 GSM

PAPER MERCHANDISE

SIZE	CASE PACK	KRAFTT	WHITE
6 x 9 †	1000	\$42.00	\$48.00
8½ x 11	1000	\$51.00	\$63.00
12 x 15	1000	\$79.00	\$100.00
12 x 3 x 18	500	\$59.00	\$74.00

† Ink-Printing not available on this size

All sizes: One case minimum for Ink-Printing or Hot-Stamping

INK-PRINTING

1st Side	2nd Side (Additional)
Minimum Quantity Order: 32¢ per bag	Minimum Quantity Order: 42¢ per bag
1000+ bags: 30¢ per bag	1000+ bags: 40¢ per bag

HOT-STAMPING

1st Side	2nd Side (Additional)
Minimum Quantity Order: 40¢ per bag	Minimum Quantity Order: 40¢ per bag
1000+ bags: 38¢ per bag	1000+ bags: 38¢ per bag

Sizes do not combine for custom-print pricing

Custom Print Information: [pgs. 21-29](#) • All pricing is RESALE • Prices subject to change without notice

JCUT TWIST

Foldover Top
Twisted Paper Handles
Kraft + White

New Product



PRODUCT HIGHLIGHTS

- Foldover top
- Twisted paper handles
- 140 GSM
- Cardboard bottom insert included

PRINT SPECS

- One-color per side
- Two-sided printing available

JCUT TWIST

SIZE	CASE PACK	KRAFT	WHITE	PRINTING MINIMUM
6¼ x 3½ x 8½	200	\$122.80	\$135.40	600 3 cases
8 x 5 x 10	200	\$133.60	\$146.20	600 3 cases
10 x 5 x 13	200	\$144.40	\$162.40	600 3 cases
16 x 6 x 12	100	\$106.60	\$122.80	500 5 cases
16 x 6 x 19	100	\$126.40	\$149.80	500 5 cases

INK-PRINTING

1st Side	2nd Side (Additional)
Minimum Quantity Order: 32¢ per bag	Minimum Quantity Order: 42¢ per bag
1000+ bags: 30¢ per bag	1000+ bags: 40¢ per bag

HOT-STAMPING

1st Side	2nd Side (Additional)
Minimum Quantity Order: 40¢ per bag	Minimum Quantity Order: 40¢ per bag
1000+ bags: 38¢ per bag	1000+ bags: 38¢ per bag

Sizes do not combine for custom-print pricing

Custom Print Information: [pgs. 21-29](#) • All pricing is RESALE • Prices subject to change without notice



KRAFT

SIZE	CASE PACK	PER CASE	PRINTING MINIMUM
6¼ x 3½ x 8½	200	\$144.20	600 3 cases
8 x 4¾ x 10¼	200	\$169.40	600 3 cases
10 x 5 x 13	200	\$201.70	600 3 cases
13 x 5 x 10	200	\$208.60	600 3 cases
16 x 6 x 12	100	\$131.90	500 5 cases
16 x 6 x 19	100	\$175.20	500 5 cases

PRODUCT HIGHLIGHTS

- Foldover top
- Twill woven handles
- 140 GSM
- Cardboard bottom insert included

PRINT SPECS

- One-color per side
- Two-sided printing available

INK-PRINTING

1st Side	2nd Side (Additional)
Minimum Quantity Order: 32¢ per bag	Minimum Quantity Order: 42¢ per bag
1000+ bags: 30¢ per bag	1000+ bags: 40¢ per bag

HOT-STAMPING

1st Side	2nd Side (Additional)
Minimum Quantity Order: 40¢ per bag	Minimum Quantity Order: 40¢ per bag
1000+ bags: 38¢ per bag	1000+ bags: 38¢ per bag

Sizes do not combine for custom-print pricing

Custom Print Information: [pgs. 21-29](#) • All pricing is RESALE • Prices subject to change without notice

JCUT TWILL

Foldover top • Twill Handles
Kraft w/ Black



PRODUCT HIGHLIGHTS

- Foldover top
- Twill woven handles
- 140 GSM
- Cardboard bottom insert included

PRINT SPECS

- One-color per side
- Two-sided printing available

KRAFT w/ BLACK

SIZE	CASE PACK	PER CASE	PRINTING MINIMUM
6¼ x 3½ x 8½	200	\$151.60	600 3 cases
8 x 4¾ x 10¼	200	\$175.60	600 3 cases
10 x 5 x 13	200	\$222.90	600 3 cases
13 x 5 x 10	200	\$229.90	600 3 cases
16 x 6 x 12	100	\$140.80	500 5 cases
16 x 6 x 19	100	\$182.50	500 5 cases

INK-PRINTING

1st Side	2nd Side (Additional)
Minimum Quantity Order: 32¢ per bag	Minimum Quantity Order: 42¢ per bag
1000+ bags: 30¢ per bag	1000+ bags: 40¢ per bag

HOT-STAMPING

1st Side	2nd Side (Additional)
Minimum Quantity Order: 40¢ per bag	Minimum Quantity Order: 40¢ per bag
1000+ bags: 38¢ per bag	1000+ bags: 38¢ per bag

Sizes do not combine for custom-print pricing

Custom Print Information: [pgs. 21-29](#) • All pricing is RESALE • Prices subject to change without notice



WHITE

SIZE	CASE PACK	PER CASE	PRINTING MINIMUM
6¼ x 3½ x 8½	200	\$156.90	600 3 cases
8 x 4¾ x 10¼	200	\$179.80	600 3 cases
10 x 5 x 13	200	\$222.20	600 3 cases
13 x 5 x 10	200	\$229.50	600 3 cases
16 x 6 x 12	100	\$141.50	500 5 cases
16 x 6 x 19	100	\$186.00	500 5 cases

PRODUCT HIGHLIGHTS

- Foldover top
- Twill woven handles
- 140 GSM
- Cardboard bottom insert included
- PRINT SPECS**
- One-color per side
- Two-sided printing available

INK-PRINTING

HOT-STAMPING

INK-PRINTING		HOT-STAMPING	
1st Side	2nd Side (Additional)	1st Side	2nd Side (Additional)
Minimum Quantity Order: 32¢ per bag	Minimum Quantity Order: 42¢ per bag	Minimum Quantity Order: 40¢ per bag	Minimum Quantity Order: 40¢ per bag
1000+ bags: 30¢ per bag	1000+ bags: 40¢ per bag	1000+ bags: 38¢ per bag	1000+ bags: 38¢ per bag

Sizes do not combine for custom-print pricing

Custom Print Information: [pgs. 21-29](#) • All pricing is RESALE • Prices subject to change without notice

JCUT TWILL

Foldover Top • Twill Handles
White w/ Black



WHITE w/ BLACK

SIZE	CASE PACK	PER CASE	PRINTING MINIMUM
6¼ x 3½ x 8½	200	\$156.10	600 3 cases
8 x 4¾ x 10¼	200	\$181.60	600 3 cases
10 x 5 x 13	200	\$235.70	600 3 cases
13 x 5 x 10	200	\$242.70	600 3 cases
16 x 6 x 12	100	\$147.40	500 5 cases
16 x 6 x 19	100	\$197.20	500 5 cases

PRODUCT HIGHLIGHTS

Foldover top
Twill woven handles
140 GSM
Cardboard bottom insert included

PRINT SPECS

One-color per side
Two-sided printing available

INK-PRINTING

1st Side	2nd Side (Additional)
Minimum Quantity Order: 32¢ per bag	Minimum Quantity Order: 42¢ per bag
1000+ bags: 30¢ per bag	1000+ bags: 40¢ per bag

HOT-STAMPING

1st Side	2nd Side (Additional)
Minimum Quantity Order: 40¢ per bag	Minimum Quantity Order: 40¢ per bag
1000+ bags: 38¢ per bag	1000+ bags: 38¢ per bag

Sizes do not combine for custom-print pricing

Custom Print Information: [pgs. 21-29](#) • All pricing is RESALE • Prices subject to change without notice



COLORS

SIZE	CASE PACK	PER CASE	PRINTING MINIMUM
6¼ x 3½ x 8½	200	\$163.60	600 3 cases
8 x 4¾ x 10¼	200	\$182.40	600 3 cases
10 x 5 x 13	200	\$233.00	600 3 cases
13 x 5 x 10	200	\$239.80	600 3 cases
16 x 6 x 12	100	\$147.40	500 5 cases
16 x 6 x 19	100	\$194.40	500 5 cases

PRODUCT HIGHLIGHTS

- Foldover top
- Twill woven handles
- 140 GSM
- Cardboard bottom insert included

PRINT SPECS

- One-color per side
- Two-sided printing available



Aqua Black » Cerise Chocolate » Gray Navy » Red

INK-PRINTING

HOT-STAMPING

INK-PRINTING		HOT-STAMPING	
1st Side	2nd Side (Additional)	1st Side	2nd Side (Additional)
Minimum Quantity Order: 32¢ per bag	Minimum Quantity Order: 42¢ per bag	Minimum Quantity Order: 40¢ per bag	Minimum Quantity Order: 40¢ per bag
1000+ bags: 30¢ per bag	1000+ bags: 40¢ per bag	1000+ bags: 38¢ per bag	1000+ bags: 38¢ per bag

Sizes do not combine for custom-print pricing

For best Ink-Printing results, we recommend using a very dark-colored Ink on a lighter-colored bag.
» Ink-Printing cannot be done on Black, Chocolate, or Navy.

Custom Print Information: [pgs. 21-29](#) • All pricing is RESALE • Prices subject to change without notice

TINT TOTES

Premium Paper • Non-Laminated



PRODUCT HIGHLIGHTS

- Foldover top
- Twill woven handles
- 170 GSM
- Cardboard bottom insert included
- Interior color matches exterior color

STAMP SPECS

- One-color per side
- Two-sided
- Hot-Stamping available

TINT TOTES

BAGS SIZE	CASE PACK	1-4 CASES	5+ CASES	PRINTING MINIMUM
5¼ x 3½ x 6	100	\$132.00	\$121.00	500 5 cases
6¼ x 3½ x 8½	100	\$147.40	\$136.40	500 5 cases
8 x 4 x 10	100	\$156.20	\$145.20	500 5 cases
10 x 5 x 13	100	\$178.20	\$167.20	500 5 cases
13 x 5 x 10	100	\$180.40	\$171.60	500 5 cases
16 x 6 x 12	100	\$224.40	\$213.40	500 5 cases
16 x 6 x 19 ▲	100	\$268.40	\$257.40	300 3 cases



Black



Celery



Robin's Egg



Rose



Sand



Slate Gray



Willow

HOT-STAMPING

1st Side
40¢ per bag

2nd Side (Additional)
40¢ per bag

▲ Larger Sizes: Additional 10¢ per imprint • Ink-Printing is not available on this product

Custom Print Information: [pgs. 21-29](#) • All pricing is RESALE • Prices subject to change without notice



MANHATTANS

BAGS SIZE	CASE PACK	1-4 CASES	5+ CASES	PRINTING MINIMUM
6¼ x 3½ x 6½	100	\$144.10	\$133.10	500 5 cases
5½ x 3½ x 12½	100	\$165.00	\$158.40	500 5 cases
6½ x 3½ x 12½	100	\$178.20	\$167.20	500 5 cases
8 x 4 x 10	100	\$168.20	\$157.20	500 5 cases
13 x 5 x 10	100	\$213.80	\$202.80	500 5 cases
16 x 6 x 12	100	\$277.90	\$266.90	500 5 cases
20 x 7 x 16 Δ	50	\$217.80	\$208.00	300 6 cases
21 x 13½ x 15 ◇	50	\$327.80	\$318.00	N/A

PRODUCT HIGHLIGHTS

- Foldover top
- Twill woven handles
- White: 180 GSM
- Kraft: 200 GSM
- Cardboard bottom insert included

◇ Plain Only

STAMP SPECS

- One-color per side
- Two-sided
- Hot-Stamping available

HOT-STAMPING

1st Side

40¢ per bag

2nd Side (Additional)

40¢ per bag

Δ Larger Sizes:

Additional 10¢ per imprint

Ink-Printing is not available on this product

COLOR/SIZE AVAILABILITY



SIZE	KRAFT/BLACK	KRAFT/KRAFT	KRAFT/WHITE	WHITE/BLACK	WHITE/WHITE
6¼ x 3½ x 6½	✓	✓	✓	✓	✓
5½ x 3½ x 12½	✓	N/A	N/A	✓	N/A
6½ x 3½ x 12½	✓	N/A	N/A	✓	N/A
8 x 4 x 10	✓	✓	✓	✓	✓
13 x 5 x 10	✓	✓	✓	✓	✓
16 x 6 x 12	✓	✓	✓	✓	✓
20 x 7 x 16	✓	✓	✓	✓	✓
21 x 13½ x 15	✓	N/A	N/A	N/A	N/A

Custom Print Information: [pgs. 21-29](#) • All pricing is RESALE • Prices subject to change without notice

EUROTOTES

Luxe Paper • Laminated • White



PRODUCT HIGHLIGHTS

- Foldover top
- Twill woven handles
- 180 GSM
- Cardboard bottom insert included
- Matte or Gloss laminated finish

STAMP SPECS

- Hot-Stamping Only
- One-color per side
- Two-sided Hot-Stamping available
- Matte Only

MATTE + GLOSS

BAGS SIZE	CASE PACK	1-4 CASES	5+ CASES	PRINTING MINIMUM
5½ x 3½ x 6	100	\$144.10	\$133.10	500 5 cases
6¼ x 3½ x 8½	100	\$165.00	\$158.40	500 5 cases
8 x 4 x 10	100	\$178.20	\$167.20	500 5 cases
9 x 3¼ x 7	100	\$168.20	\$157.20	500 5 cases
13 x 5 x 10	100	\$213.80	\$202.80	500 5 cases
16 x 6 x 12	100	\$277.90	\$266.90	500 5 cases
16 x 6 x 18 ▲	100	\$363.00	\$352.00	300 3 cases
20 x 7 x 16 ▲	50	\$217.80	\$208.00	300 6 cases
24 x 9 x 19 ▪	50	\$327.80	\$318.00	N/A

HOT-STAMPING

1st Side
40¢ per bag

2nd Side (Additional)
40¢ per bag

▲ **Larger Sizes:** Additional 10¢ per imprint • Ink-Printing is not available on this product

Custom Print Information: [pgs. 21-29](#) • All pricing is RESALE • Prices subject to change without notice



COLORS

BAGS SIZE	CASE PACK	1-4 CASES	5+ CASES	PRINTING MINIMUM
5½ x 3½ x 6	100	\$144.10	\$133.10	500 5 cases
6¼ x 3½ x 8½	100	\$165.00	\$158.40	500 5 cases
8 x 4 x 10	100	\$178.20	\$167.20	500 5 cases
13 x 5 x 10	100	\$213.80	\$202.80	500 5 cases
16 x 6 x 12	100	\$277.90	\$266.90	500 5 cases
20 x 7 x 16 ▲	50	\$217.80	\$208.00	300 6 cases

PRODUCT HIGHLIGHTS

- Foldover top
- 180 GSM
- Cardboard bottom insert included
- Laminated finish
- Gloss available in Black only

STAMP SPECS

- One-color per side
- Two-sided
- Hot-Stamping available

HOT-STAMPING

1st Side
40¢ per bag

2nd Side (Additional)
40¢ per bag

Ink-Printing is not available on this product

▲ Larger Sizes:

Additional 10¢ per imprint

The Eurotote Inventory is being switched from Rope Handles to Twill woven handles. As the Rope Handle inventory is depleted, it will be replaced with Twill woven handles. See the reference grid below for which bag color and size is available with which handle type. If you need a specific handle type, please contact us for the current inventory status. When a Rope Handle item switches to Twill, we will not alert you to this transition; it will just occur.

Handle types by color + size	GLOSS				MATTE			
SIZE	BLACK	BLACK	CRÈME	HUNTER	NAVY	FUCHSIA	GOLD	SILVER
5½ x 3½ x 6	Woven	Woven	N/A	Rope	Rope	N/A	Woven	Woven
6¼ x 3½ x 8½	Woven	Woven	Woven	Woven	Woven	Woven	Woven	Woven
8 x 4 x 10	Woven	Woven	Woven	Woven	Woven	Woven	Woven	Woven
13 x 5 x 10	N/A	Woven	Rope	Woven	Woven	Rope	Woven	Woven
16 x 6 x 12	Woven	Woven	Woven	Woven	Woven	Woven	Woven	Woven
20 x 7 x 16	N/A	Woven	Woven	N/A	Woven	Woven	N/A	N/A

Custom Print Information: [pgs. 21-29](#) • All pricing is RESALE • Prices subject to change without notice

JEWELRY BOXES

Kraft, White + Black

New Product



KRAFT + WHITE



BLACK

BOX	SIZE	CASE PACK	PER CASE
#21	2½ x 1½ x 7⁄8	100	\$68.20
#32	3 1⁄6 x 2 1⁄8 x 1	100	\$72.60
#33	3½ x 3½ x 1	100	\$82.10
#33D	3½ x 3½ x 1½	100	\$86.70
#34	3½ x 3½ x 2	100	\$105.70
#53	5¼ x 3¾ x 7⁄8	100	\$96.20
#65	6 x 5 x 1	50	\$72.30
#75	7 x 5½ x 1	50	\$88.10
#82A	8 x 2 x 7⁄8	100	\$103.80
#85	8 x 5½ x 1¼	50	\$102.40

BOX	SIZE	CASE PACK	PER CASE
#32	3 1⁄6 x 2 1⁄8 x 1	100	\$77.00
#33	3½ x 3½ x 1	100	\$85.80
#34	3½ x 3½ x 2	100	\$109.40
#53	5¼ x 3¾ x 7⁄8	100	\$100.00
#82A	8 x 2 x 7⁄8	100	\$107.60
#85	8 x 5½ x 1¼	50	\$105.70



White



White Krome



Kraft

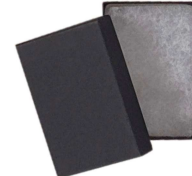

Black matte w/
white interior

PRINT SPECS

Hot-Stamping available, lid only • One-color only
30¢ per box • Minimum: 500 boxes per plate size

PRODUCT HIGHLIGHTS

Two piece: Lids and bases sold together
Rigid white-lined board • Cotton insert included

Plate Fee: \$170.00

Box sizes using the same plate can be combined to meet the 500 box minimum

Custom Print Information: [pgs. 21-29](#) • All pricing is RESALE • Prices subject to change without notice



GARMENT BAGS

QUANTITY	LENGTH	COLORS	CLEAR
1 Roll	Any	\$216.60	\$184.30
2-5 Rolls	Any	\$210.90	\$176.80
6+ Rolls	Any	\$199.10	\$162.90

COLOR/SIZE AVAILABILITY

COLORS	38"	40"	54"	72"
Black 	✓	N/A	✓	✓
Cerise 	N/A	N/A	✓	✓
Crème 	✓	N/A	✓	N/A
Gray 	N/A	✓	✓	N/A
Light Pink 	N/A	N/A	✓	✓
Mauve 	N/A	N/A	✓	✓
Navy 	N/A	✓	N/A	N/A
Turquoise 	N/A	N/A	✓	✓
White 	✓	N/A	✓	✓
Clear Light - .0065 mil	✓	N/A	✓	N/A
Clear Heavy - .001 mil	✓	N/A	✓	✓
BAGS PER ROLL + GAUGE	38"	40"	54"	72"
Bags/Roll: Colors @ .001 mil	444	422	312	234
Bags/Roll: Clear Light @ .0065 mil	510	N/A	359	N/A
Bags/Roll: Clear Heavy @ .001 mil	331	N/A	233	175

PRODUCT HIGHLIGHTS

Perforated-on-a-roll
Smooth film

SHIPPING WEIGHT

Clear: 21 lbs
Color: 26 lbs

GUSSET WIDTH

Clear: 4"
Color: 3"

ADDITIONAL COLORS AVAILABLE

8 roll minimum • Use pricing above for 6+ rolls
Colors available: Chocolate, Purple, Red, Sky Blue, Teal + Yellow

All pricing is RESALE • Prices subject to change without notice

CUSTOM GARMENT BAGS

Perforated-on-Rolls



PLATE COST

Plates are billed at cost. Average costs range from \$175 to \$350, depending on the plate size. Proof and plate costs must be approved before production begins. Plate costs are not provided until AFTER an order is placed.

PRODUCT HIGHLIGHTS

Perforated on-a-roll
Smooth film

2-COLOR 1-SIDE

Use 1-color, 2-sides price

SHIPPING WEIGHT:

Clear: 21 lbs
Color: 26 lbs

CUSTOM PMS:

\$200

LOGO/ART PLACEMENT

An 18" Random Repeat is standard on printed garment bags. Each print will begin 18" from the top of the previous print and repeat down the film roll. The print may fall across bag perforations, and each bag may have a different number of imprints based.

REQUEST A QUOTE FOR:

Spot Print | Thicker than 1 mil
10000+ Quantity

Pricing is for 1.0 mil		1M		2M		3M		5M	
BAG SIZE	COLOR/SIDES	WHITE	COLORS	WHITE	COLORS	WHITE	COLORS	WHITE	COLORS
21 x 3 x 36	1-C, 1-S	\$893.30	\$957.70	\$631.20	\$695.80	\$544.20	\$608.10	\$446.80	\$511.40
468/roll	1-C, 2-S	\$1,435.10	\$1,499.40	\$912.60	\$977.00	\$802.50	\$838.90	\$560.20	\$624.10
21 x 3 x 38	1-C, 1-S	\$910.70	\$974.60	\$649.80	\$712.80	\$561.00	\$625.50	\$464.50	\$528.70
444/roll	1-C, 2-S	\$1,453.10	\$1,511.30	\$929.20	\$996.30	\$792.90	\$820.40	\$577.70	\$641.60
21 x 3 x 40	1-C, 1-S	\$927.70	\$991.50	\$665.70	\$729.50	\$577.90	\$641.60	\$481.50	\$545.70
422/roll	1-C, 2-S	\$1,471.10	\$1,535.40	\$948.00	\$1,015.30	\$774.30	\$838.50	\$598.80	\$659.80
21 x 3 x 48	1-C, 1-S	\$994.50	\$1,007.90	\$732.20	\$796.80	\$622.80	\$680.20	\$548.50	\$612.60
351/roll	1-C, 2-S	\$1,540.30	\$1,606.70	\$1,020.30	\$1,068.50	\$845.50	\$909.80	\$666.60	\$731.10
21 x 3 x 54	1-C, 1-S	\$1,055.90	\$1,117.80	\$810.60	\$875.10	\$722.90	\$786.80	\$598.70	\$662.80
312/roll	1-C, 2-S	\$1,623.60	\$1,703.40	\$1,101.40	\$1,161.60	\$991.10	\$1,014.20	\$741.00	\$805.30
21 x 3 x 60	1-C, 1-S	\$1,132.00	\$1,415.90	\$870.90	\$934.20	\$783.50	\$848.00	\$671.00	\$740.40
281/roll	1-C, 2-S	\$1,688.00	\$1,760.60	\$1,174.30	\$1,230.20	\$991.10	\$1,014.20	\$741.00	\$805.30
21 x 3 x 72	1-C, 1-S	\$1,278.40	\$1,342.40	\$1,016.40	\$1,080.90	\$930.20	\$994.00	\$827.50	\$891.80
234/roll	1-C, 2-S	\$1,848.40	\$1,913.00	\$1,326.10	\$1,389.90	\$1,151.50	\$1,215.80	\$953.20	\$1,073.60

STOCK INK COLORS	BLACK	COPPER 876	GOLD 871	ORANGE 021	PANTONE BLUE	PANTONE GREEN	PANTONE PURPLE	PANTONE YELLOW	PROCESS MAGENTA	RED 185	REFLEX BLUE	RHOD. RED	RUBINE RED	SILVER 877	WARM RED	WHITE

FILM COLORS	BLACK	CERISE	CHOC.	CITRUS	CREME	GRAY	HUNTER	LT. PINK	MAUVE	NAVY	PURPLE	RED	SKY BLUE	TEAL	TURQ.	WHITE	YELLOW

All pricing is RESALE • Prices subject to change without notice

PRODUCT HIGHLIGHTS

Lo-density

High gloss

Smooth film

Die-cut handles

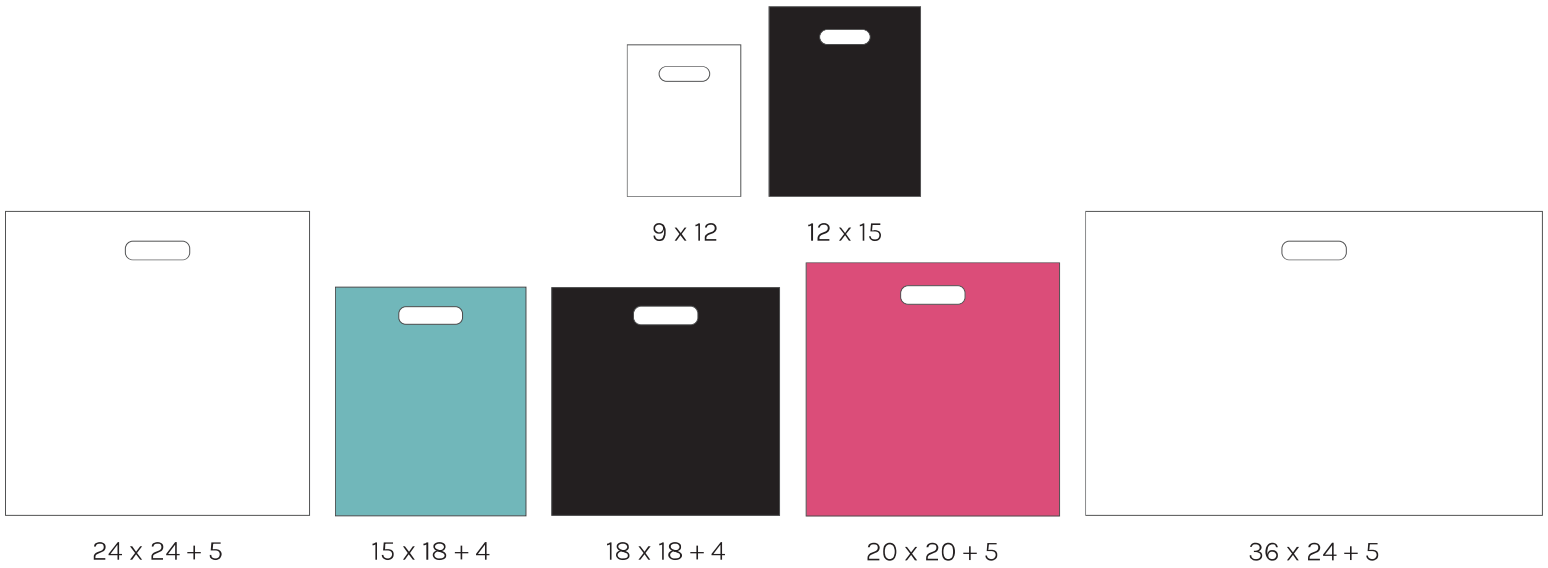

SIZE	GAUGE	CASE PACK	1-4 CASES	5-9 CASES	10+ CASES
9 x 12	1.25 mil	1000	\$113.40	\$97.70	\$94.60
12 x 15	1.25 mil	1000	\$172.30	\$152.50	\$147.70
15 x 18 + 4	1.25 mil	500	\$145.20	\$126.20	\$125.10
18 x 18 + 4	1.25 mil	500	\$168.50	\$159.70	\$152.50
20 x 20 + 5	1.5 mil	500	\$203.10	\$179.50	\$173.80
24 x 24 + 5	1.5 mil	500	\$292.40	\$281.10	\$270.90
36 x 24 + 5	1.75 mil	250	\$338.80	\$319.70	\$315.40

COLOR/SIZE AVAILABILITY



	WHITE	BLACK	CITRUS	DUSTY ROSE	HUNTER GREEN	IVORY	MAGENTA	NAVY BLUE	PURPLE	RED	TURQUOISE
15 x 18 + 4	✓	✓	✓	✓	✓	✓	✓	✓	✓	✓	✓
20 x 20 + 5	✓	✓	✓	✓	✓	✓	✓	✓	✓	✓	✓
9 x 12	✓	✓	N/A	N/A	N/A	N/A	N/A	N/A	N/A	N/A	N/A
12 x 15	✓	✓	N/A	N/A	N/A	N/A	N/A	N/A	N/A	N/A	N/A
18 x 18 + 4	✓	✓	N/A	N/A	N/A	N/A	N/A	N/A	N/A	N/A	N/A
24 x 24 + 5	✓	N/A	N/A	N/A	N/A	N/A	N/A	N/A	N/A	N/A	N/A
36 x 24 + 5	✓	N/A	N/A	N/A	N/A	N/A	N/A	N/A	N/A	N/A	N/A

All pricing is RESALE • Prices subject to change without notice

PLASTIC BAGS

Frosty • Merchandise + Shopper

PRODUCT HIGHLIGHTS

Merchandise Bags:

Flat bag

Die-cut handles



Shopper Bags:

Soft-loop handles

Cardboard bottom insert

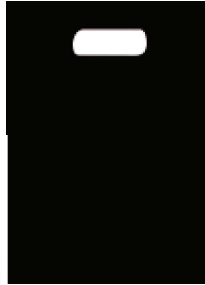

FROSTY MERCHANDISE

SIZE	GAUGE	CASE PACK	CLEAR PER CASE	EBONY PER CASE
9 x 12	2.75 mil	500	\$55.00	\$66.00
12 x 15	2.75 mil	500	\$75.90	\$93.50
16 x 19	2.75 mil	250	\$66.00	\$88.00

FROSTY SHOPPERS

SIZE	GAUGE	CASE PACK	CLEAR PER CASE	EBONY PER CASE
8 x 5 x 10 x 5	3 mil	250	\$60.50	\$77.00
10 x 5 x 13 x 5	3 mil	250	\$72.60	N/A
13 x 7 x 17 x 7	3 mil	250	\$90.20	N/A
16 x 6 x 12 x 6	3 mil	250	\$99.00	\$123.20
16 x 6 x 18 x 6	3 mil	250	\$114.40	\$137.50
18 x 10 x 22 x 10	4 mil	100	\$137.50	N/A

HI-DENSITY

T-Shirt • Hi-Density

PRODUCT HIGHLIGHTS

Lightweight
T-Shirt style
or flat
(No handles)



T-SHIRT

SIZE	GAUGE	CASE PACK	PER CASE
12 x 7 x 23	.0006 mil	1000	\$60.50
14 x 8 x 25	.0008 mil	1000	\$66.00
18 x 8 x 30	.0009 mil	500	\$58.30
24 x 15 x 36	.001 mil	250	\$63.80

HI-DENSITY

SIZE	GAUGE	CASE PACK	PER CASE
24 x 6 x 36	.00085 mil	300	\$63.80

CLOSEOUT

Tint Totes w/ Rope Handles



SIZE	CASE PACK	PER CASE	AQUA	CERISE	CHOCOLATE	EGGPLANT	GRAPE	IVORY	PERIWINKLE	RED
5¼ x 3½ x 6	100	\$53.00	✓	✓	N/A	✓	N/A	✓	✓	✓
6¼ x 3½ x 8½	100	\$60.00	N/A	N/A	✓	N/A	N/A	N/A	✓	✓
8 x 4 x 10	100	\$63.00	✓	✓	N/A	N/A	✓	✓	N/A	N/A
10 x 5 x 13	100	\$72.00	N/A	✓	✓	N/A	N/A	N/A	N/A	✓
13 x 5 x 10	100	\$74.00	✓	N/A	✓	N/A	✓	✓	N/A	N/A
16 x 6 x 12	100	\$91.00	✓	N/A	✓	✓	✓	N/A	N/A	N/A
16 x 6 x 19	100	\$110.00	N/A	✓	✓	N/A	✓	✓	N/A	N/A

All pricing is RESALE • Prices subject to change without notice

Ink-Printed



Hot-Stamped



INK-PRINT + HOT-STAMP

Hot-Stamping and Ink-Printing are two distinct methods used for adding designs or text to bags. Each print type is available for select bag styles and sizes as noted throughout the catalog.

These compatibility parameters are proven to ensure the cleanest and best printed product for your custom printed packaging needs.

DIFFERENCES BETWEEN INK-PRINT + HOT-STAMP | WHEN TO USE EACH

	INK-PRINTING	HOT-STAMPING
PROCESS	Directly applies Ink to the bag through flexography printing by depositing a layer of Ink which is absorbed into the substrate of the product's surface.	Uses heat and pressure to transfer a foil onto the bag's surface. A metal die is heated and pressed on to the foil and bag material.
FOIL VS INK	INK: Better suited for intricate designs and white or light colored bags.	FOIL: Used for a metallic or shiny finish and full art color opacity on Kraft or color bags.
FINISH	Results in a matte finish. The appearance can vary based on the shade of the product being printed.	Produces a glossy, reflective finish, giving bags a luxurious feel. Foil is available in metallic, satin, or matte finishes.
DESIGN COMPLEXITY	Can handle complex designs with thin lines and fine details more effectively than Hot-Stamping.	Best suited for simple designs or artwork. Intricate designs may fill-in, become illegible, or fail to print.
LEAD TIMES	Shorter lead time due to quick set-up time and high-volume printing process.	Longer lead time due to set-up time and individual bag printing process.
PRINTABLE BAG TYPES	Serrated-Edge Shoppers • Serrated-Edge Merchandise JCUT Twist or Twill	Serrated-Edge Shoppers • Serrated-Edge Merchandise JCUT Twist or Twill • Manhattan Totes • Tint Totes • Eurototes

KRAFT BAG w/ WHITE INK-PRINT



Kraft and color bags absorb white or light Ink colors which can change the look of the finished product.

It may appear vintage or distressed, which works great for many types of product / stores.



KRAFT BAG w/ WHITE HOT-STAMP

Hot-stamped foil will not absorb into the bag, thus creating a clean and opaque printed finish.

White or light color foils have a more pronounced print on kraft and color bags.



All pricing is RESALE • Prices subject to change without notice

ARTWORK REQUIREMENTS

All artwork files must be submitted to with the **PO#, Customer/Ship-to name**, and **ARTWORK** in the subject line.

Artwork is subject to acceptance by the Art Department based on quality, printability, product type, material color, print color, print method, and production capabilities.

Artwork files must be submitted digitally via email as Adobe Illustrator files (.AI file type—vector format) with a confirming PDF file. After an individual review, the Art Department may accept other file formats.

All fonts must be converted to outlines and any graphic source files must be submitted along with the artwork file and PDF.

Our Art Department will not alter or change the submitted artwork. It is the customer's responsibility to promptly provide a revised artwork file and approved proof (if applicable). A revised proof will be sent for approval before production begins.

PLACEMENT

Our team aims to horizontally and vertically center the printed artwork on the bag. However, due to various bag elements (handle type, handle location, crease/fold location, gusset folds, fold-over tops, and bag sizes), the artwork placement may need to be slightly shifted for a clean and visually balanced printed product. We reserve the right to make these decisions during production without contacting the customer for approval.

Specific bag styles and sizes cannot have the print area perfectly centered vertically. There is limited vertical print space area on certain bags. Artwork height must be reduced or the print area will be positioned closer to the bottom of the bag. See below:

SHORT PRINT AREA = NEED FOR SHORTER PRINT SIZE



Taller logo on bag with a short print area. Logo cannot be centered vertically, must be placed toward bottom of bag.



Shorter logo on bag with a short print area. Logo can be centered vertically. Applies to 5x3x8, 5x3x12, 6x3x12, 6x3x8, 9x3x7, 13x5x10, + 16x6x12 bags



ARTWORK GUIDELINES

Large coverage areas and reverse-out designs are not recommended, especially for Hot-Stamping.

All fonts should be a minimum size of 9pt to ensure clear printing. However, depending on the font characteristics, some fonts may need to be larger to prevent the areas between letters or inside letters from filling-in, becoming illegible, or failing to print.

Detailed art elements, thin lines, and small white spaces may need to be thickened or adjusted to ensure they do not fill-in or fail to print. White space may be required between art elements for better readability.

Registration, Copyright, or Trademark symbols may need to be increased in size to ensure printing and legibility. If the artwork contains one of these marks outside of the principal elements, the customer must inform the Art Department whether the artwork should be centered including or excluding the symbol.

TOLERANCES

Registration: 1/8"
Side-to-Side Alignment: 1/8"

SCREENS

Artwork with screens cannot be Ink-printed or Hot-Stamped

STANDARDS

Positive Line ≥ 2pt
Negative Line ≥ 3pt
Positive Type ≥ 9pt
Thin Positive Type ≥ 11pt
Negative Type ≥ 11pt bold
Thin Neg. Type ≥ 13pt bold

COMPATIBILITY: PRINT TYPE + PRINT COLOR + MATERIAL

Ink colors may appear different on the finished product based on the bag material, bag color, Ink color, and the Ink's water-soluble nature. The Ink color swatches shown are based on printing on a white bag under ideal conditions.

Light Ink colors, light-colored foils, white ink, and ink colors similar to the product color may appear dull and may not be visible or legible on kraft or colored bags.

All ink and foil swatches in this catalog are a CMYK representation of Pantone or foil colors.

To see the most accurate color:

Ink-Printing

Reference a Pantone Color Bridge Uncoated Guide.

Hot-Stamping/Foil

Reference the Swatch Sheet provided in the Print Kit.

All pricing is RESALE • Prices subject to change without notice

PROOFING PROCESS

Our Art Department will review all submitted artwork and approved proofs for usability. If an approved proof is not provided, our team will email one within two business days of the order confirmation receipt if no further information is needed.

An approved proof is required for all orders that include a new plate (new art or replacement art) or a new bag size/style using a plate on file. After we review the files provided, the customer is responsible for any necessary revisions. Once revised, the customer must submit the revised artwork file and PDF. Our Art Department will review the revised files and either send a new proof for approval or note any further changes needed.

PDF proofs should be viewed at 100% on a regular-sized monitor (not a mobile device or tablet). The colors on the monitor or screen are not the same as those on the final product or imprinted color. All colors on proofs are digital representations of product color, Pantone Ink, or foil colors.

Once everything is correct, reply to the most recent proof email with "Approved for Production." After this is received, the Art Department will order plates, and the lead time for the order will begin. Lead times vary, including an extended lead time during holiday buying months.

PLATE PRICES SUBJECT TO CHANGE		
INK-PRINT	PLATE SIZE	HOT-STAMP
\$130.00	< 30 sq. in	\$170.00
\$174.00	31 - 40 sq. in	\$200.00
\$200.00	41 - 50 sq. in	\$230.00
\$250.00	51 - 60 sq. in	\$270.00
\$300.00	61 - 70 sq. in	\$320.00
AT COST	70 sq. in +	AT COST

After production, plates are stored on file for future orders. If a plate remains unused for three years, it will be discarded.

ADDITIONAL FEES

FEE TYPE:	APPLIES TO:	INK-PRINT	HOT-STAMP
Plate Change	Two-sided printing with a different plate for each side	\$120.00	\$180.00
Color Change	Two-sided printing with a different color for each side	\$150.00	\$150.00
LOT Charge	Any bag size that does not meet the minimum qty. of bags per bag size	\$200.00	\$250.00

ABOVE FEES ARE APPLIED PER BAG SIZE WITHIN AN ORDER

ALL MAXIMUM PRINT AREAS ARE SUBJECT TO ARTWORK ACCEPTANCE

BAGS TYPES AVAILABLE FOR EACH SIZE BY CODE

Eurotote (ET)	JCUT (JC)	Manhattan (MH)	Serrated-Edge (SE)	Tint Tote (TT)

DIMENSION LINES LEGEND

	Ink-Print		Hot-Stamp		Bag Midpoint
---	-----------	---	-----------	---	--------------

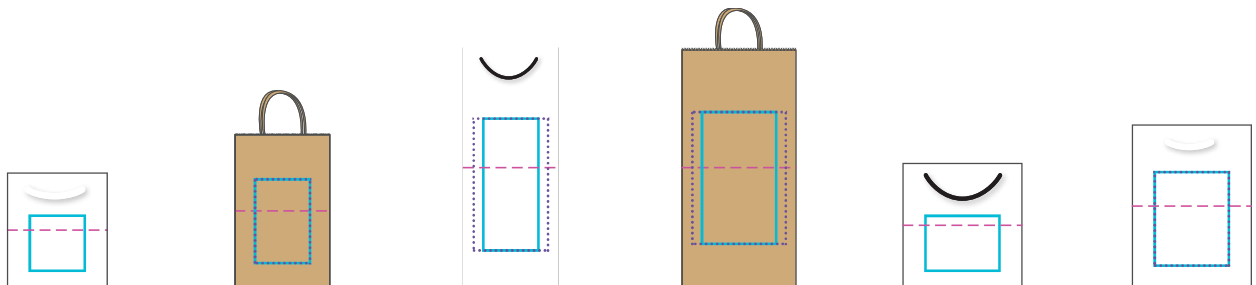

BAG SIZE	5 1/4 x 3 1/2 x 6		5 x 3 x 8		5 x 3 x 12 1/2		6 x 3 x 12 1/2		6 1/4 x 3 1/2 x 6 1/2		6 1/4 x 3 1/2 x 8 1/2	
PRINT TYPE	INK-PRINT	HOT-STAMP	INK-PRINT	HOT-STAMP	INK-PRINT	HOT-STAMP	INK-PRINT	HOT-STAMP	INK-PRINT	HOT-STAMP	INK-PRINT	HOT-STAMP
MAX. PRINT AREA	N/A	3 x 3	3 x 4 1/2	3 x 4 1/2	4 x 7	3 x 7	5 x 7	4 x 7	N/A	4 x 3	4 x 5	4 x 5
BAG TYPE		ET • TT	SE	SE	SE	MH • SE	SE	MH • SE		MH	JC	ET • JC • TT

All pricing is RESALE • Prices subject to change without notice

CUSTOM PRINTING

Max. Print Areas

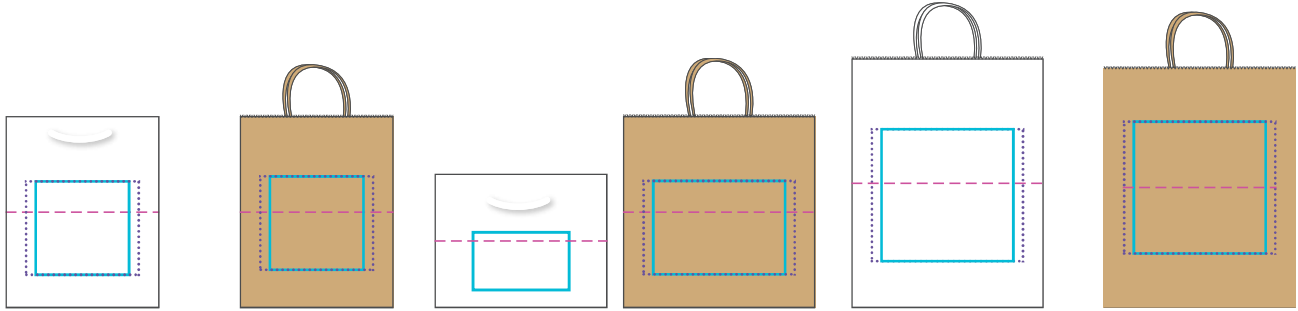

BAG SIZE	8 x 4 x 10		8 x 5 x 10		9 x 3¼ x 7		10 x 5 x 10		10 x 5 x 13		10 x 7 x 12½	
PRINT TYPE	INK-PRINT	HOT-STAMP	INK-PRINT	HOT-STAMP	INK-PRINT	HOT-STAMP	INK-PRINT	HOT-STAMP	INK-PRINT	HOT-STAMP	INK-PRINT	HOT-STAMP
MAX. PRINT AREA	N/A	5 x 5	6 x 5	5 x 5	N/A	5 x 3	8 x 5	7 x 5	8 x 7	7 x 7	8 x 7	7 x 7
BAG TYPE		ET • MH • TT	JC • SE	JC • SE		ET	SE	SE	JC • SE	JC • SE • TT	JC • SE	JC • SE • TT

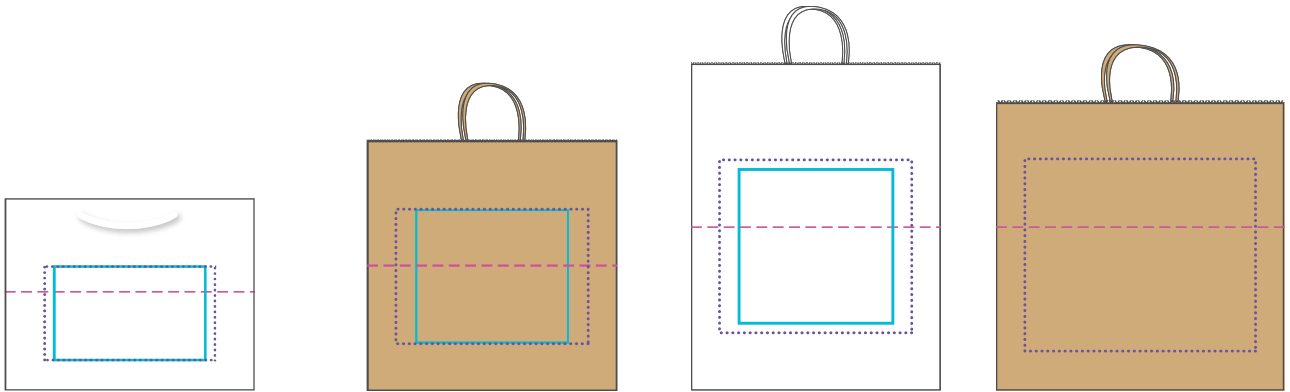

BAG SIZE	13 x 5 x 10		13 x 7 x 13		13 x 7 x 17		15 x 10 x 15	
PRINT TYPE	INK-PRINT	HOT-STAMP	INK-PRINT	HOT-STAMP	INK-PRINT	HOT-STAMP	INK-PRINT	HOT-STAMP
MAX. PRINT AREA	9 x 5	8 x 5	10 x 7	8 x 7	10 x 9	8 x 8	12 x 10	N/A
BAG TYPE	JC • SE	ET • JC • MH • SE • TT	SE	SE	SE	SE	SE	

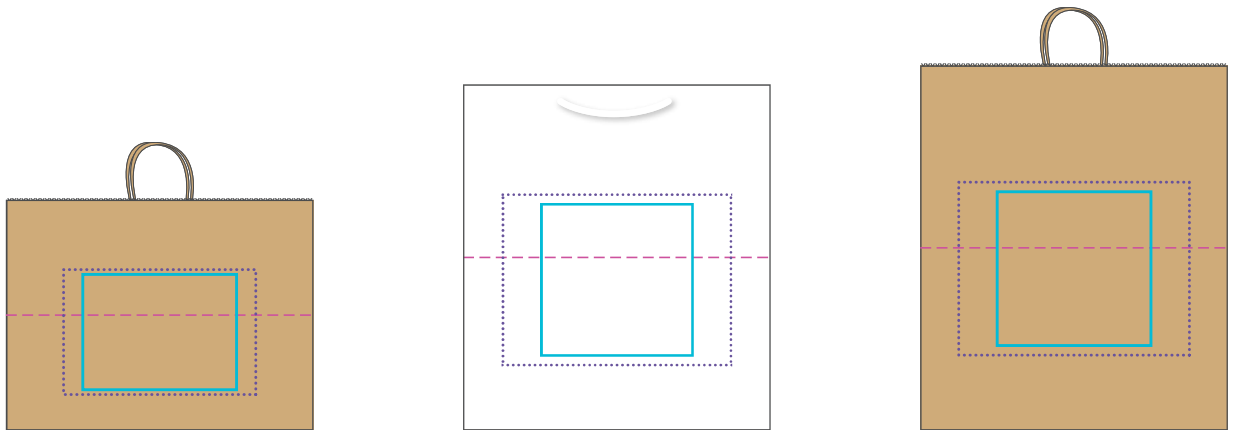

BAG SIZE	16 x 6 x 12		16 x 6 x 18		16 x 6 x 19	
PRINT TYPE	INK-PRINT	HOT-STAMP	INK-PRINT	HOT-STAMP	INK-PRINT	HOT-STAMP
MAX. PRINT AREA	12 x 6½	8 x 6	N/A	8 x 8	12 x 9	8 x 8
BAG TYPE	JC • SE	ET • JC • MH • SE • TT		ET • TT	JC • SE	JC • SE

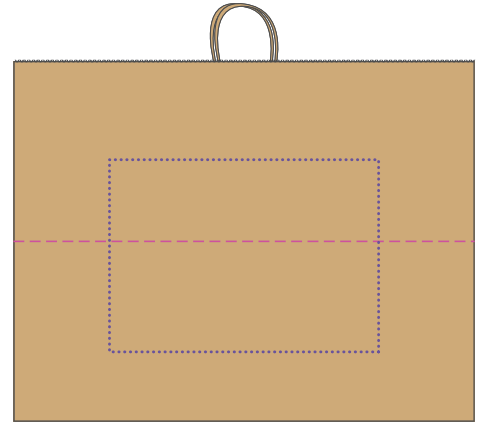
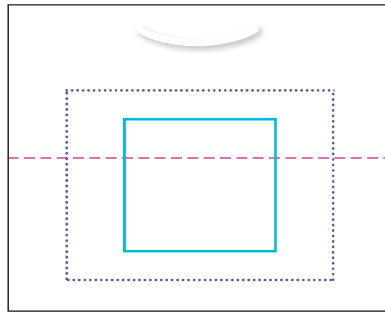
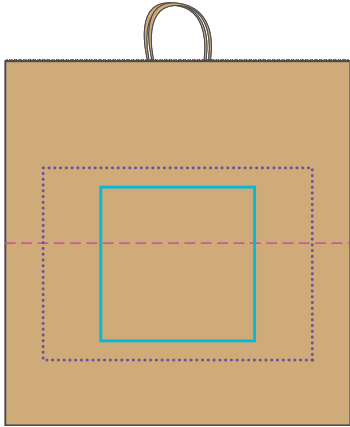

BAG SIZE	18 x 7 x 19		20 x 7 x 16		24 x 7 x 18	
PRINT TYPE	INK-PRINT	HOT-STAMP	INK-PRINT	HOT-STAMP	INK-PRINT	HOT-STAMP
MAX. PRINT AREA	14 x 10	8 x 8	N/A	8 x 7	14 x 10	N/A
BAG TYPE	SE	SE		ET • MH	SE	

PAPER MERCHANDISE

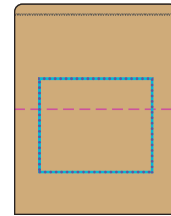
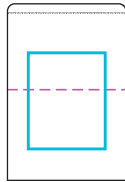

BAG SIZE	6¼ x 9¼		8½ x 11	
PRINT TYPE	INK-PRINT	HOT-STAMP	INK-PRINT	HOT-STAMP
MAX. PRINT AREA	N/A	4 x 5	6 x 5	6 x 5

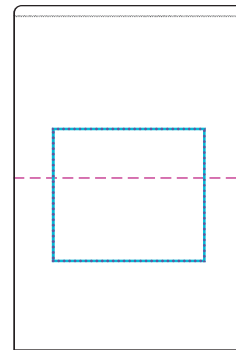
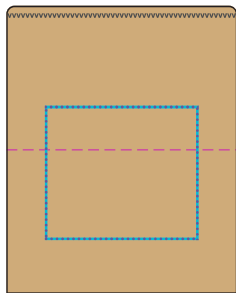

BAG SIZE	12 x 15		12 x 3 x 18	
PRINT TYPE	INK-PRINT	HOT-STAMP	INK-PRINT	HOT-STAMP
MAX. PRINT AREA	8 x 7	8 x 7	8 x 7	8 x 7

INK-PRINTING SWATCHES

Use PMS Number
when placing order

PMS 185 Holiday Red	PMS 186 Imperial Red	PMS 199 Vivid Red	PMS 180 Indian Red	PMS 1805 Firebrick Red	PMS 1807 Bloody Mary	PMS 194 Merlot	PMS 208 Cabernet	PMS 165 Pumpkin
PMS 173 Russet Orange	PMS 021 Primary Orange	PMS 1525 Burnt Orange	PMS 722 Butterscotch Orange	PMS 7410 Cantaloupe	PMS 143 Merigold	PMS 110 Goldenrod Orange	PMS 108 Primary Yellow	PMS 7485 Pastel Green
PMS 5777 Moss	PMS 383 Pea Green	PMS 375 Spring Bud	PMS 376 Apple Green	PMS 360 Shiny Green	PMS 7489 Matte Lime	PMS 576 Fairway Green	PMS 2278 Flat Green	PMS 357 Dark Emerald
PMS 354 Spring Green	PMS 348 Primary Green	PMS 335 Dark Turquoise	PMS 3425 Lawn Green	PMS 5545 Natural Jade	PMS 554 Dark Pea Green	PMS 342 Deep Sea Green	PMS 343 Hunter	PMS 350 Dark Fern Green
PMS 560 Everglade	PMS 378 Swamp	PMS 384 Coconut Green	PMS 5757 Camouflage	PMS 392 Olive	PMS 385 Deep Olive	PMS 5645 Sea Glass	PMS 318 Light Sea Green	PMS 3242 Bright Sea Green
PMS 556 Dull Sea Green	PMS 570 Sea Green	PMS 326 Turquoise	PMS 3262 Medium Turquoise	PMS 327 Dark Turquoise	PMS 321 Teal	PMS 3282 Green Teal	PMS 328 Dark Green Teal	PMS 322 Dark Teal
PMS 3145 Blue Lagoon	PMS 5483 Saxon Blue	PMS 8205 Dusty Ocean Blue	PMS 631 Light Aqua	PMS 305 Aqua	PMS 3115 Medium Aqua	PMS 3125 Medium-Dark Aqua	PMS 312 Dark Aqua	PMS 2995 Cerulean
PMS 299 Dark Cerulean	PMS 7461 Matte Cerulean	PROCESS BLUE Process Blue	PMS 7454 Air Force Blue (RAF)	PMS 646 Wedgewood Blue	PMS 660 Baltic Blue	PMS 285 Primary Blue	PMS 801 Celestial Blue	PMS 6125 Dark Celestial Blue

Custom PMS Color: \$200 • All pricing is RESALE • Prices subject to change without notice

Use PMS Number
when placing order

INK-PRINTING SWATCHES

PMS 2153 Imperial Blue	PMS 7469 Peacock Blue	PMS 5415 Stone Blue	PMS 308 Ocean Blue	PMS 2376 Independence Blue	PMS 534 Medium Sapphire	PMS 309 Dark Sapphire	PMS 2728 Spanish Blue	PMS 293 Chelsea Blue
PMS 286 Blue Galaxy	PMS 2736 Everton Blue	REFLEX BLUE Reflex Blue	PMS 72 Blue	PMS 281 Navy	PMS 2955 Yale Blue	PMS 295 Dark Yale Blue	PMS 2716 Lavender Gray	PMS 258 African Violet
PMS 527 Iris	PMS 2597 Primary Purple	PMS 268 Dark Purple	PMS 526 Dark Orchid	PMS 520 Grape	PMS 519 Eggplant	PMS 262 Grape Juice	PMS 2745 Indigo Purple	PMS 274 Regalia Purple
PMS 2090 Ultra Violet	PANTONE VIOLET Violet	PMS 5185 Native Wine	PMS 511 Pompadour	PMS 505 Pansy Purple	PMS 209 Deep Ruby Purple	PMS 1815 Sangria	PMS 1767 Pastel Pink	PMS 700 Light Pink
PMS 1775 Salmon	PMS 211 Pink	PMS 232 Dark Pink	PMS 1915 Dragon Fruit	PMS 205 Blush	PMS 226 Deep Pink	PMS 8003 Khaki	PMS 4515 Brushed Brass	PMS 470 Bronze
PMS 490 Burnt Henna	PMS 7610 Ruddy Brown	PMS 477 Brown	PMS 4625 Dark Brown	PMS 476 Coffee	PMS 497 Deep Coffee	COOL GRAY 4 Cool Gray 4	PMS 422 Medium Gray	PMS 424 Fossil Gray
	PMS 425 Anchor Gray	COOL GRAY 11 Cool Gray 11	PMS 409 Stone Gray	WARM GRAY 8 Warm Gray 8	PMS 444 Light Charcoal	PMS 431 Light Gunmetal	PMS 432 Gunmetal	
		PMS 877 SILVER Silver	PMS 876 COPPER Copper	PMS 871 GOLD Gold	BLACK Black	WHITE White		

Custom PMS Color: \$200 • All pricing is RESALE • Prices subject to change without notice

HOT-STAMPING SWATCHES

Metallic

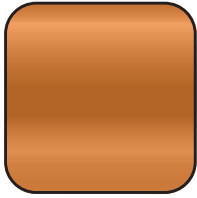

Metallic
Copper

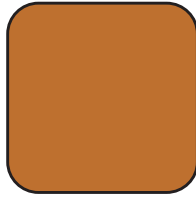

Matte
Copper



Metallic
Champagne

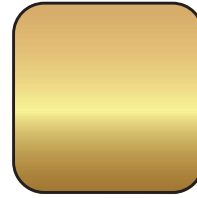

Metallic
Gold



Matte
Gold

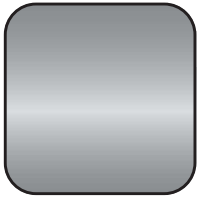

Metallic
Silver

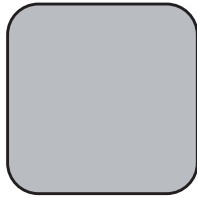

Matte
Silver



Metallic
Pewter

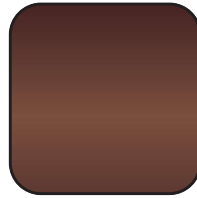

Metallic
Brown

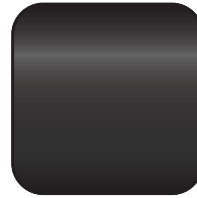

Metallic
Black



Metallic
Blue



Metallic
Dark Blue



Metallic Blue
Frost Satin

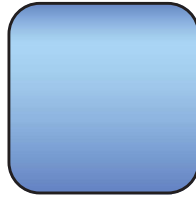

Metallic
Pearl Blue

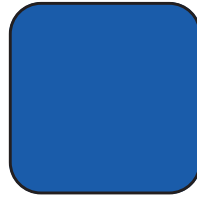

Metallic
Blue Satin



Metallic
Lime



Metallic
Green



Metallic
Sage Satin

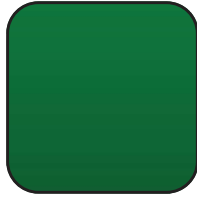

Metallic
Forest Satin

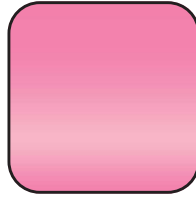

Metallic
Pink



Metallic
Fuchsia

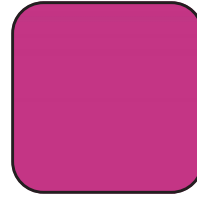

Metallic
Raspberry Satin

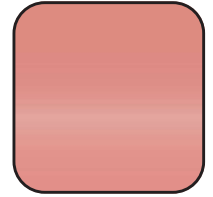

Metallic
Rose Gold

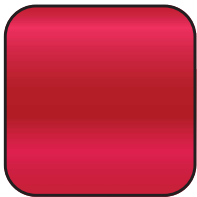

Metallic
Red

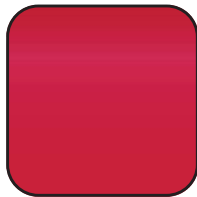

Metallic
Red Satin



Metallic Candy
Apple Red



Metallic
Burgundy



Metallic
Maroon



Metallic
Purple

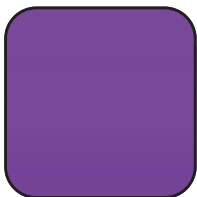

Metallic
Purple Satin



Metallic
Light Purple



Metallic
Lavender Satin



Metallic
Teal Satin



Metallic
Teal

HOT-STAMPING SWATCHES

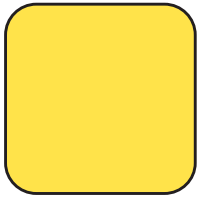

Matte Yellow

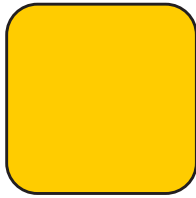

Matte Sunflower

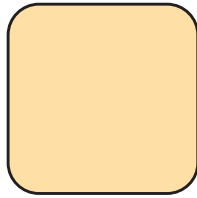

Matte Ivory

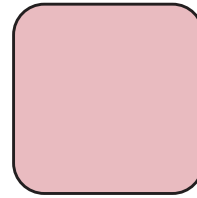

Matte Blush

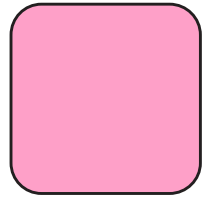

Matte Bubblegum



Matte Pink

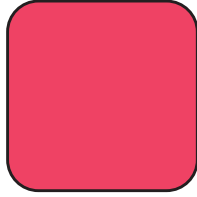

Matte Hot Pink

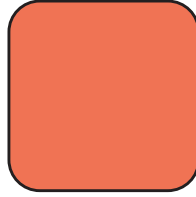

Matte Orange

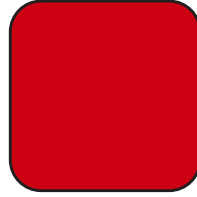

Matte Deep Red

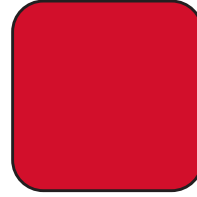

Matte Red

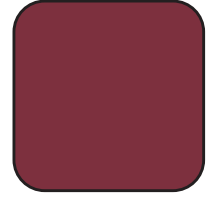

Matte Burgundy

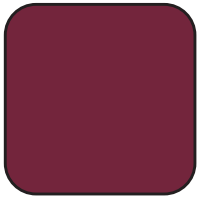

Matte Maroon

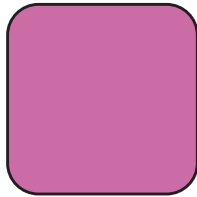

Matte Orchid

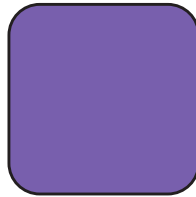

Matte Purple

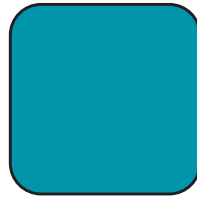

Matte Turquoise

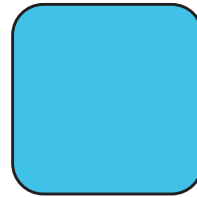

Matte Cyan Blue



Matte Royal Blue



Matte Medium Blue



Matte Navy

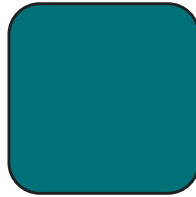

Matte Teal

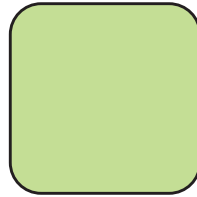

Matte Light Green

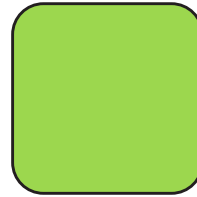

Matte Lime

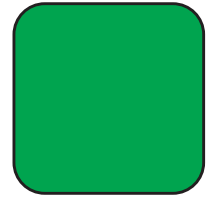

Matte Green

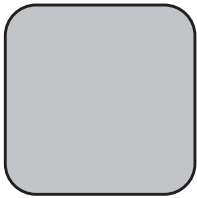

Matte Light Gray



Matte Medium Gray



Matte Dark Gray

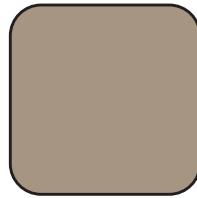

Matte Taupe



Matte Chocolate



Matte Dark Chocolate

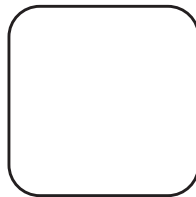

Matte White



Matte Black

PRODUCT CATALOG

Your source for in-stock merchandise



**NEW PRODUCT
for 2026!**

Envelope Gift Bags - Pg. 3



Jewelry Boxes - Pg. 16



JCUT Twist Handle - Pg. 6

Pricing as of April 13th

2026