

# DISPLAY FIXTURES & PACKAGING

See page 2-5



See page 110



See page 35



See page 74

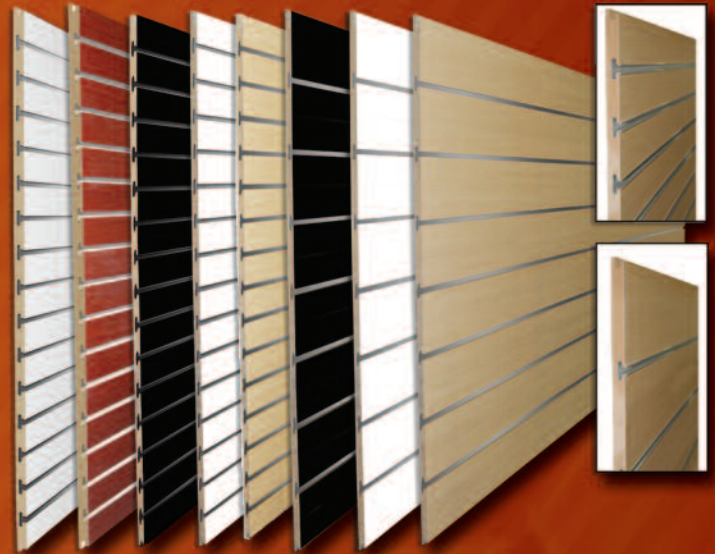

See page 48-50



See page 52-54

See page 22-25



See page 92-101



# Industrial Style Pipe Fixtures

See page 64



**Jewelry Leatherette Display**

**Revolving Slatwall Display**

**Hat Displays**

See page 73



See page 51

See page 55

# In this catalog...

<b>Aaron Contemporary</b> .....	92-101	<b>Boxes</b> .....	35	<b>Racks</b>	
<b>Accessory Displays</b>		<b>Cases</b> .....	46, 93	Aaron Contemporary .....	92, 101
Belt .....	58, 101	<b>Displays</b> .....	46-54, 98	Accessory .....	58
Bra .....	104	<b>Tags</b> .....	26	Alta System .....	67
Gloves .....	59	<b>Knockdown Displays</b>		Bauhaus Series .....	66
Hats .....	58-59, 95, 99	Bases / Cubes .....	73	Chainlink .....	68-69
Hosiery .....	59	Slatwall .....	73	Designer 400 .....	65
Purse .....	58-59, 101	Showcases .....	124-125	Industrial .....	64
Shoes .....	58, 99	<b>Tables</b> .....	73	Ladder System .....	63
<b>Body Parts</b> .....	55, 104	<b>Lucite Displays</b>		Low Cost .....	56-57
<b>Business Forms and Sales Books</b> .....	32	Card Frames & Sign Holders .....	42	Milano System .....	65
<b>Casters</b> .....	16-17, 56-58, 60-62, 64	Counter Displays .....	44-46	Mirage Mini Ladder .....	63
<b>Clamps</b> .....	41	Gridwall Accessories .....	81	Rectangular .....	60-61
<b>Counter Bases and Displays</b> .....	59, 127-128	Earring and Eyewear Displays .....	46	Rolling Racks .....	17, 60-63, 92
<b>Dressing Room</b> .....	15	Mirrors .....	43	Satin Nickel .....	63
<b>Dump Bins</b> .....	15, 73	Slatwall Displays .....	76-77	<b>Salesman's Equipment</b>	
<b>Easels</b> .....	41, 45	<b>Make-up Masks &amp; Hygienic Liners</b> .....	12	Collapsible Racks .....	17
<b>Finials</b> .....	100, 109	<b>Mannequins</b>		Griptite .....	17
<b>Forms and Bases</b>		Abstract .....	115-117	Hangers .....	16
Aaron Contemporary .....	100, 107	Childrens .....	122-123	Sample Cases .....	16
Bases .....	100, 105-108, 110	Euro .....	113, 118-119	<b>Security Devices</b> .....	15
Brazilian .....	104	Headless .....	113-115, 122	<b>Shelves</b>	
Children's .....	107, 110	Headless Torso's .....	111-112	Glass .....	89
Dressmaker's .....	105	Low Cost .....	114-115, 120	Gondola .....	90-91
Jersey Forms .....	106-107, 110	Voluptuous .....	119	Plastic .....	72
Flexible Childrens Forms .....	110	<b>Mini Binning Grids</b> .....	89	Wire Shelving .....	83
French Design Forms .....	100, 105-107	<b>Mirrors</b> .....	43, 97	Wood .....	72-73
Hanging Forms .....	105, 107, 110	<b>Outriggers</b> .....	64, 86, 96	<b>Showcases</b>	
Molded Forms .....	102-103	<b>P.O.P Displays</b> .....	59	Aaron Contemporary .....	93
Neckblocks .....	100, 106-107, 109	<b>Packaging</b>		Bellissimo .....	126-127
<b>Garment Bags</b> .....	18, 20	Bagging Equipment .....	20	Frameless Glass .....	128
<b>Gift Certificates</b> .....	32	Bags-Frosted Shopping .....	21	Knockdown .....	124-125
<b>Gridwall and Accessories</b> .....	79-82	Bags-Garment .....	18, 20	<b>Shoe Displays</b> .....	58
<b>Glass Binning &amp; Shelves</b> .....	88-89	Bags-Jewelry .....	19, 51	<b>Shopping Carts</b> .....	15
<b>Gondola Shelving</b> .....	90-91	Bags-Low Cost Plastic .....	19	<b>Size Dividers</b> .....	13
<b>Hangers</b>		Bags-Paper Merchandise .....	23	<b>Signage</b>	
Accessories .....	2, 4, 7, 10, 33	Bags-Paper Shopping .....	22-23	Banners and Message Signs .....	38-40
Children's .....	5, 7-8	Bags-Polyethylene .....	20	Literature Holders .....	44, 76, 81
Display .....	8	Boxes-Apparel and Gift .....	34	Signholders .....	41-42
Plastic .....	6-9	Boxes-Jewelry .....	35	<b>Slatwall Displays</b> .....	73
Printed .....	2-4	Printed Packaging .....	24-25	<b>Slatwall &amp; Accessories</b> .....	74-78
Metal-Chrome .....	9, 16	Ribbons and Bows .....	37	<b>Spot Removers and Accessories</b> .....	11
Salesman's .....	16	Tissue Paper .....	36	<b>Standards &amp; Accessories</b> .....	84-87
Satin Lingerie .....	8	<b>Pins</b> .....	12	<b>Steamers</b> .....	11
Specialty .....	8-9	<b>Pricing Equipment</b>		Supplies .....	10-15
Wood .....	2-5	Price Labelers .....	30	<b>Tables</b> .....	64, 73, 94
<b>Hooks and Clips</b> .....	14	Price Tags .....	26-28	<b>Vinyl Garment Bags</b> .....	18
<b>Jewelry</b>		Tagging Guns & Fasteners .....	31	<b>Wall Systems</b> .....	63-65, 67, 86, 95-96
Bags .....	19, 51	Utility Tags .....	29	<b>Wigs</b> .....	121
		<b>Public Guidance</b> .....	70-71		

# Wooden Hangers

## H100 SERIES

### 17" x 1/2" Contoured Wooden Suit Hanger with Lockbar

#### #H100BLK

Black gloss finish with chrome hook.

#### #H100NF

Natural waxed finish with chrome hook.

#### #H100WB

Walnut finish with brass hook.

#### #H100VAR

Clear natural varnish with chrome hook.

#### #H100-19VAR

19" Clear natural varnish with chrome hook.

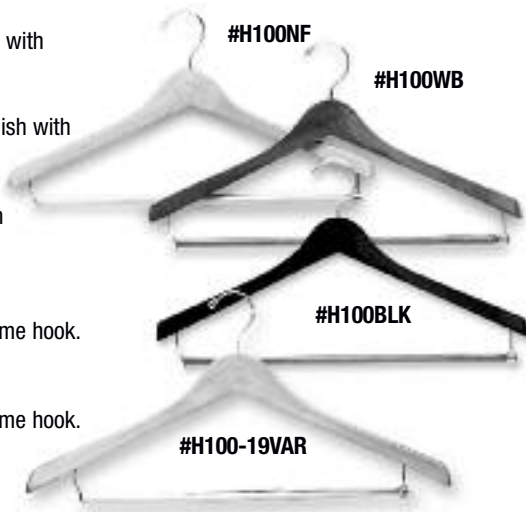

## H300 SERIES

### 17" x 1/2" Contoured Wooden Suit Hanger with Clips and Notches

#### #H300NF

Natural waxed finish with chrome hardware.

#### #H300WB

Walnut finish with brass hardware.

#### #H300VAR

Clear natural varnish with chrome hardware.

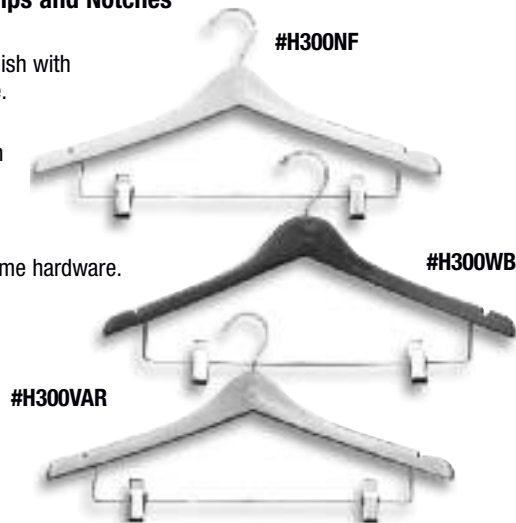

## H200 SERIES

### 17" x 1/2" Contoured Wooden Coat Hanger

#### #H200BLK

Black gloss finish with chrome hook and notches.

#### #H200NF

Natural waxed finish with chrome hook.

#### #H200NF/NO

Natural waxed finish with chrome hook and notches.

#### #H200WB

Walnut finish with brass hook.

#### #H200WB/NO

Walnut finish with brass hook and notches.

#### #H200WC/NO

Walnut finish with chrome hook and notches.

#### #H200VAR

Clear natural varnish with chrome hook.

#### #H200VAR/NO

Clear natural varnish with chrome hook and notches.

#### #H200-19VAR

19" Clear natural varnish with chrome hook.

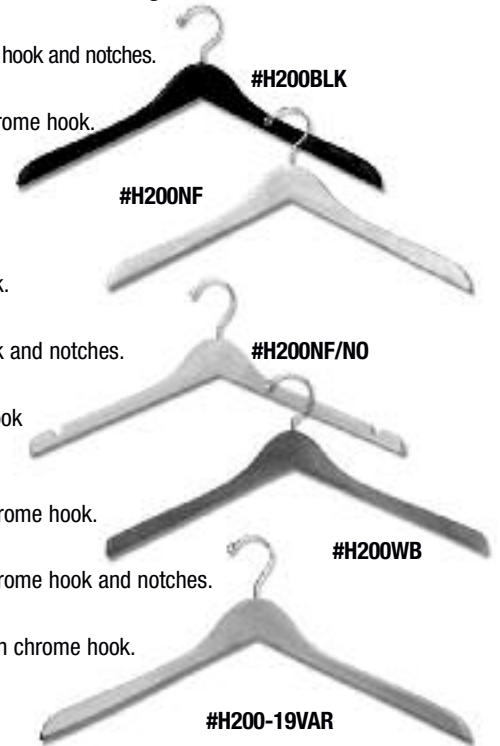

## H400 SERIES

### 14" x 7/16" Wooden Pant & Skirt Hanger with Clips

#### #H400BLK

Black gloss finish with chrome hook.

#### #H400NF

Natural waxed finish with chrome hardware.

#### #H400WB

Walnut finish with brass hardware.

#### #H400VAR

Clear natural varnish with chrome hardware.



### Hanger Printing Upcharges

Imprinting enhances your image and profits.

#### CALL FOR QUOTE

Plate Prep\*

Press Prep\*

Imprinting (per 100)

Maximum Image Size: 2 1/4" x 3/4"

Standard Inks†: Gold, Black & Silver

Special Order Inks: Call for pricing.

\*-These charges will apply to each style hanger unless the styles you have chosen are of the same size and contour.

†- Special ink color and matching charges may apply.

**Import Printing Upcharge** (90 Day lead Time)



### Adhesive Non-Slip Hanger Attachment

210 Per Pack

#MSGRIP

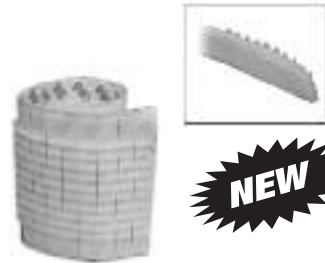

**NEW**

Please Note: Color of Wooden hangers may vary from order to order due to availability of raw materials

# Wooden Hangers

## H500 SERIES

### 16" x 5/16" Wooden Dress and Top Hanger

#### #H500NF

Natural waxed finish with chrome hook.

#### #H500WB

Walnut finish with brass hook.

#### #H500VAR

Clear natural varnish with chrome hook.

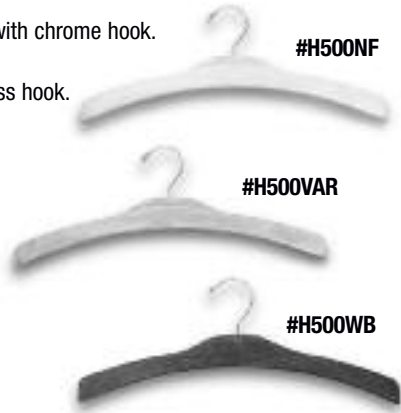

## H700 SERIES

### 17" x 1/2" Jacket Hanger

#### #H700NF

Natural waxed finish with chrome hook.

#### #H700WB

Walnut finish with brass hook.



## H600 SERIES

### 16" x 5/16" Suit and Skirt Hanger with Clips

#### #H600NF

Natural waxed finish with chrome hardware.

#### #H600WB

Walnut finish with brass hardware.

#### #H600VAR

Clear natural varnish with chrome hardware.

#### #H600WC

Walnut finish with chrome hardware.

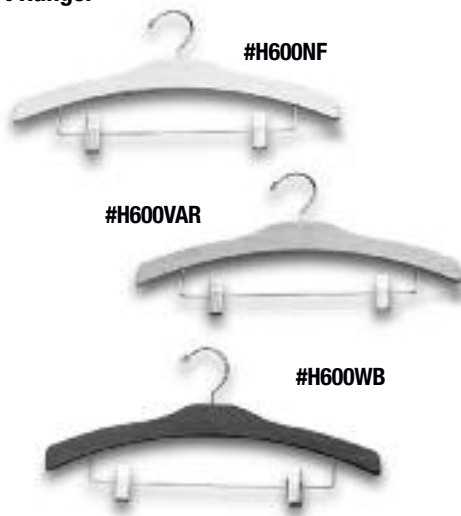

## H70 SERIES

### 16" x 7/16" Wooden Wardrobe Hanger

Natural finish with chrome hook.

#### #H70NF



## HWH SERIES

### 16" x 1/2" Laminated Wooden Top Hanger with Non-Slip Shoulder

#### #HHW/LAM100

Clear natural varnish with Non-slip Shoulders and chrome hardware.

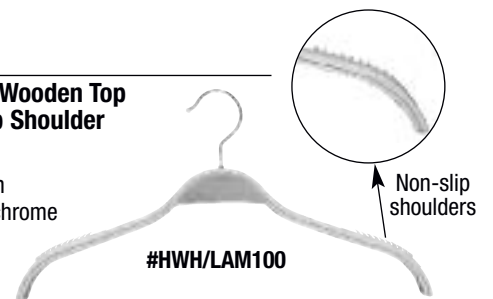

### 15" Laminated Wooden Pant Hanger with Clips

#### #HHW/LAM400

Clear natural varnish with chrome hardware.



### Hanger Printing Upcharges

Imprinting enhances your image and profits.

#### CALL FOR QUOTE

Plate Prep\*

Press Prep\*

Imprinting (per 100)

Maximum Image Size: 2 1/4" x 3/4"

Standard Inks†: Gold, Black & Silver

Special Order Inks: Call for pricing.

\*-These charges will apply to each style hanger unless the styles you have chosen are of the same size and contour.

†- Special ink color and matching charges may apply.



**Import Printing Upcharge** (90 Day lead Time)

**Please Note: Color of Wooden hangers may vary from order to order due to availability of raw materials**

# Wooden Hangers

## HW1111 SERIES

### 17" x 3/8" Notched Top & Suit Hanger

#HW1111NF

Natural waxed finish with chrome hook.

#HW1111WB

Walnut finish with brass hook.

#HW1111WC

Walnut finish with chrome hook.

#HW1111WHT

White finish with chrome hook.

#HW1111BLK

Black Gloss finish and chrome hook.

#HW1111FBK

Flat Black finish and black hook.

#HW1111VAR

Clear Natural varnish and chrome hook.

#HW1111NF/NS

Natural waxed finished and chrome hook with Non-slip shoulders.

#HW1111VAR/NS

Clear natural varnish and chrome hook with Non-slip shoulders.

#HW1111WB/NS

Walnut finish and brass hook with Non-slip shoulders.

#HW1111NF

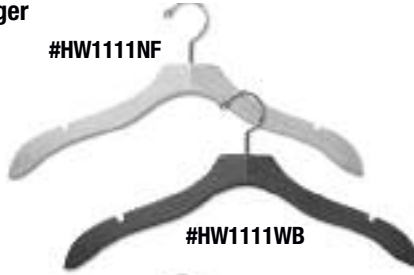

#HW1111WB

#HW1111WHT



#HW1111BLK

#HW1111FBK



#HW1111NF/NS

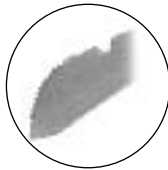

Non-slip shoulders

## HWO SERIES

### 17" x 7/16" Notched Top & Suit Hanger

#HWO1ANF

Natural waxed finish with chrome hook.

#HWO1AVAR

Clear natural varnish with chrome hook.

#HWO1AWC

Walnut finish with chrome hook.

#HWO1ABLK

Black finish with chrome hook.

#HWO1AWHT

White finish with chrome hook.

#HWO2ANF

Natural waxed finish with chrome hook.

#HWO2AVAR

Clear natural varnish with chrome hook.

#HWO2ABLK

Black finish with chrome hook.

#HWO2AWHT

White finish with chrome hook.

#HWO3ANF

Natural waxed finish with chrome hardware.

#HWO3AVAR

Clear natural varnish with chrome hardware.

#HWO3AWC

Walnut finish with chrome hardware.

#HWO3ABLK

Black finish with chrome hardware.

#HWO3AWHT

White finish with chrome hardware.

#HWO1ANF

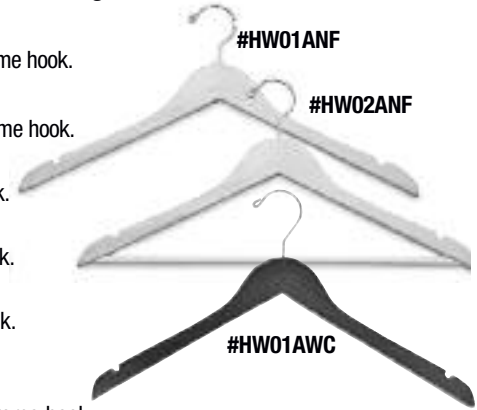

#HWO2ANF

#HWO1AWC

#HWO1AWHT

#HWO2ABLK



#HWO3ANF

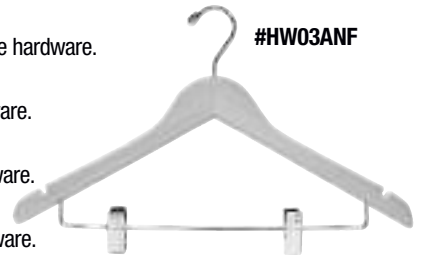

#HWO3AWC

#HWO3ABLK



#HWO3AWHT

#HWO3AVAR



### Hanger Printing Upcharges

Imprinting enhances your image and profits.

#### CALL FOR QUOTE

Plate Prep\*

Press Prep\*

Imprinting (per 100)

Maximum Image Size: 2 1/4" x 3/4"

Standard Inks†: Gold, Black & Silver

Special Order Inks: Call for pricing.

\*-These charges will apply to each style hanger unless the styles you have chosen are of the same size and contour.

†- Special ink color and matching charges may apply.



**Import Printing Upcharge** (90 Day lead Time)

### Adhesive Non-Slip Hanger Attachment

210 Per Pack

#MSGRIP



# Wooden Hangers

## H800 SERIES

### Extra Heavy 17" x 1" Contoured Coat Hanger

**#H800NF**  
Natural waxed finish with chrome hook.

**#H800WB**  
Walnut finish with brass hook.

**#H800LBNF**  
Natural waxed finish with lockbar and chrome hook.

**#H800LBWB**  
Walnut finish with lockbar and brass hook.

**#H800S3NF**  
Natural waxed finish with 10" drop and chrome hook and clips.

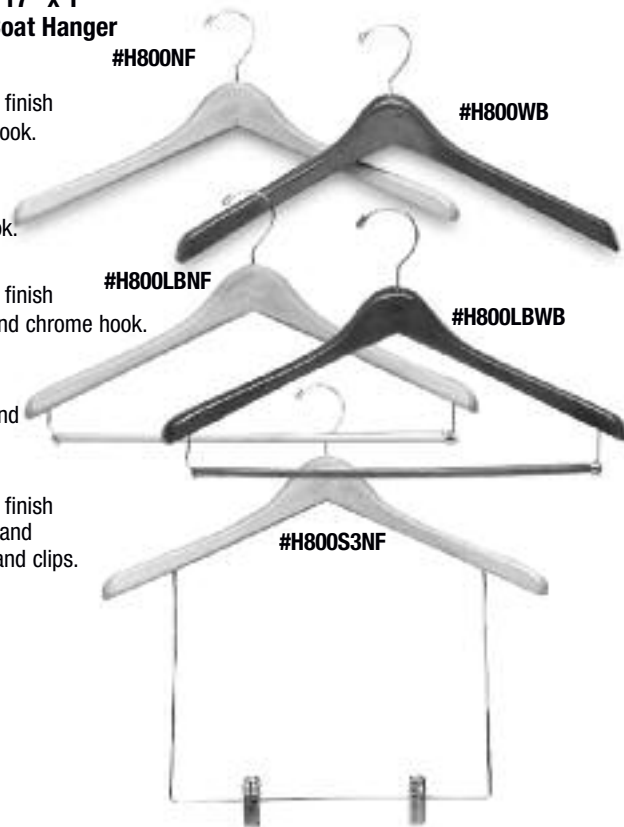

## H900 SERIES

### 14" x 1 1/16" Pant & Skirt Hanger

**#H900NF**  
Natural waxed finish with chrome hardware.

**#H900WB**  
Walnut finish with brass hardware.

**#H900WC**  
Walnut finish with chrome hardware.

**#H900WHT**  
White Satin finish with chrome hardware.

**#H900BLK**  
Black Gloss finish with chrome hardware.

**#H900FBK**  
Flat Black finish with black hardware and chrome clip bar.

**#H900VAR**  
Clear natural varnish with chrome hardware.

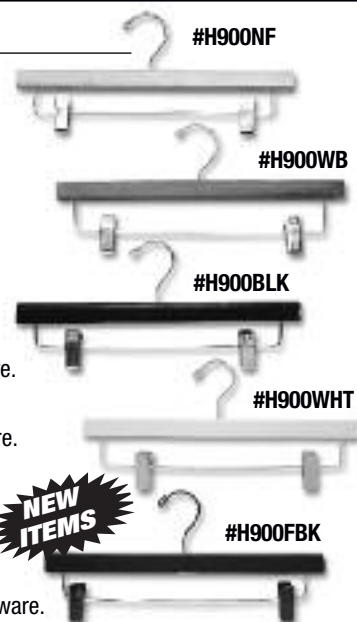

**#H907NF**  
Natural waxed finish with black Non-slip bar chrome hardware.

**#H907WB**  
Walnut finish with black Non-slip bar brass hardware.

**#H907VAR**  
Clear natural varnish with black Non-slip bar chrome hardware.

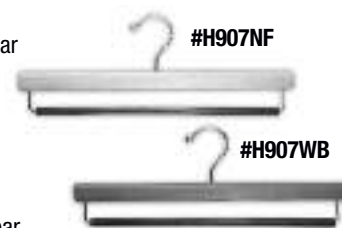

# Children's Wooden Hangers

## H500 CHILDREN'S SERIES

### 12" x 5/16" Children's Top Hanger

**#H512VAR**  
Clear natural varnish with notches and chrome hook.

**#H512WHT**  
White Satin Finish with notches and chrome hook.



## H600 CHILDREN'S SERIES

### 12" x 5/16" Children's Top Hanger

**#H612VAR**  
Clear natural varnish with chrome hook.

**#H612WHT**  
White Satin Finish with chrome hook.



## H900 CHILDREN'S SERIES

### 10" x 1 1/16" Children's Pant Hanger

**#H900VAR-10**  
Clear natural varnish with chrome hardware

**#H900WHT-10**  
White Satin finish with chrome hardware.

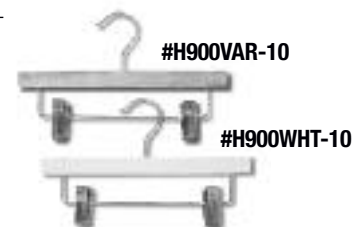

## HW1111 CHILDREN'S SERIES

### 12" x 3/8" Children's Top Hanger

**#HW1111VAR-12**  
Clear natural varnish with notches and chrome hook.

**#HW1111WHT-12**  
White Satin finish with notches and chrome hook.



# Ladies & Men's Plastic Hangers



**17" Standard Weight Hanger  
for Dresses and Blouses.**

#H4310 White Impact Plastic



**17" Heavy Weight Hanger  
for Dresses and Blouses.**

#H4110 White Impact Plastic  
#H0110 Clear Plastic  
#H2310 Black Plastic/Black Hook



**17" X-Heavy Weight Hanger  
for Dresses and Blouses.**

#H4410 White Impact Plastic  
#H0410 Clear Plastic  
#H2410 Black Plastic with Black Hook



**17" Heavy Weight Hanger  
for Suits with Cushion Clip.**

#H4311 White Impact Plastic- *Special Order*  
#H0311 Clear Plastic



**17" Heavy Weight Coat Hanger**

Regular Hook

#H0515 Clear Plastic- *Special Order*



**17" Heavy Weight Hanger**

Black plastic with a black hook.  
Extra wide collar.

#H2675 Black Plastic/Black Hook



**19" Heavy Weight Hanger**

Black plastic with Extra wide collar.

#H2675-19 Black Plastic/Black Hook  
#H2675-19CH Black Plastic/Chrome Hook



**14" Heavy Weight  
Skirt and Pant Hanger.**

#H4213 White Impact Plastic  
#H0213 Clear Plastic  
#H2213 Black Plastic with Black Hook  
& Black Plastic Clips



**14" Super Heavy Weight  
Skirt and Pant Hanger**

#H1132 Clear Plastic



# Children's Hangers



### 10" Children's Dress & Blouse Hanger

- #H4610 White Impact Plastic
- #H0610 Clear Plastic
- #H2610 Black Plastic/Black Hook



### 12" Children's Dress & Blouse Hanger

- #H4710 White Impact Plastic
- #H0710 Clear Plastic
- #H2710 Black Plastic/Black Hook



### 14" Junior Dress & Blouse Hanger

- #H4810 White Impact Plastic
- #H0810 Clear Plastic
- #H2810 Black Plastic/Black Hook



### 12" Children's Suit Hanger

Sizes 1 to 6X.

- #H4711 White Impact Plastic- *Special Order*
- #H0711 Clear Plastic



### 14" Junior Suit Hanger

Sizes 7 to 14.

- #H4811 White Impact Plastic- *Special Order*
- #H0811 Clear Plastic



### 10" Children's Skirt & Pant Hanger

with Cushion Clips.

- #H4713 White Impact Plastic
- #H0713 Clear Plastic

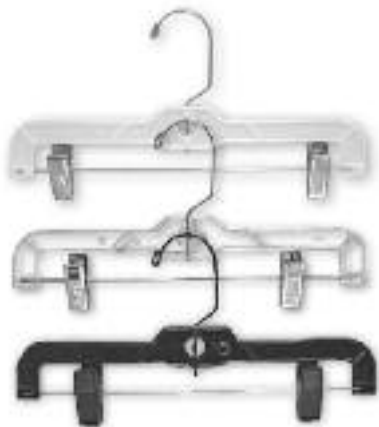

### 12" Junior Skirt & Pant Hanger

- #H4813 White Impact Plastic
- #H0813 Clear Plastic
- #H2813 Black Plastic/Black Hook & Black Plastic Clips

### Pressure Sensitive Foam Strips

Charcoal gray peel & strip.  
1600 strips per roll.

#MFOAM



### Hanger "Slip Stop"

Prevents garments from slipping off of hangers. Packed 200

#MSLIPSTOP Clear

#MSLIPSTOP/B Black



# Display & Suit Hangers



## 10" Display Hangers

10" Wide x 1½" Thick with 4" Chrome Hook  
**#HID/410** White Hanger



## 12" Display Hangers

12" Wide x 1½" Thick with 4" Chrome Hook  
**#HID/212** Black Hanger  
**#HID/412** White Hanger



## 17" Display Hangers

17" Wide x 1½" Thick with 4" Chrome Hook  
**#HID/217** Black Hanger  
**#HID/417** White Hanger



## 15" Display Hangers

15" Wide x 1½" Thick with 4" Chrome Hook  
**#HID/215** Black Hanger  
**#HID/415** White Hanger



## 19" Display Hangers

19" Wide x 2⅝" Thick with 4" Chrome Hook  
**#HID/219** Black Hanger  
**#HID/419** White Hanger

## Drops Attachments

10" drop fits 15", 17" and 19" hanger  
**#HID/DA10**



## Top and Suit Hanger

17" Black Velvet like finish.

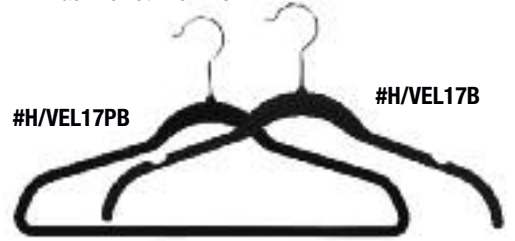

**#H/VEL17PB**

**#H/VEL17B**

## Men's Contoured Suit Hanger

17" Black Plastic with pant bar.  
**#HNS11**



## Shatterproof Pant and Skirt Hangers

10" Hanger with push-up clips.  
 Packed 200

**#HSBH10** Black Hanger

**#HSWH10** White Hanger

**#HSWH10**

**#HSBK10**



## Shatterproof Pant and Skirt Hangers

12" Hanger with push-up clips.  
 Packed 200

**#HSBK12** Black Hanger

**#HSWH12** White Hanger

**#HSBK12**

**#HSWH12**



## Satin Lingerie Hangers

15" Hanger available in Ivory, White, Pink and Black

**#HSATIN1** Ivory

**#HSATIN2** White

**#HSATIN3** Pink

**#HSATIN4** Black-**NEW ITEM**

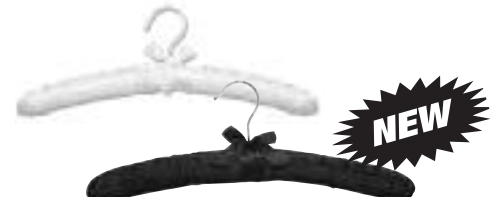

**NEW**

# All-Plastic Shipping & Specialty Hangers

## 12" Children's Top Hanger

White Plastic  
Packed 1000  
#H226



## 14" Children's Top Hanger

White Plastic  
Packed 500  
#HK14



## 16" Ladies Blouse & Dress Hanger

White Plastic  
Packed 500  
#H140



## 16" Ladies Heavyweight Blouse & Dress Hanger

White Plastic  
Packed 500  
#HP1500



## 16" Ladies Suit Hanger

For displaying tops and slacks together. White Plastic  
Packed 500  
#HP163



## 18" Men's Shirt Hanger

White or Black Plastic  
Packed 500  
#H1818B  
#H1818W



## 9" Clear Plastic Bra & Panty Hanger

Packed 1000  
#H0307



## 8" Pant/Skirt Hanger

with Coordinate Loop on Hook  
White Plastic  
Packed 250  
#H397L



## 12" Pant/Skirt Hanger

with Coordinate Loop on Hook  
White Plastic Packed 200  
#H398L

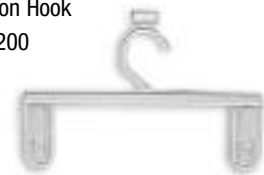

## 11" Pant/Skirt Hanger

White Plastic  
Packed 250  
#HS111



## Specialty Hangers

### Large Black Bendable Display Hanger

Packed 100  
#HBLK

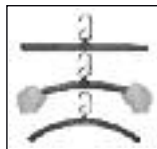

### Chrome Slack Hanger

15" Hanger with non-slipping vinyl sleeve.  
Packed 100  
#H301



### 22" Bedspread Hanger

Packed 12  
#HSBD22



# Hanger Accessories

## Hanger "Slip Stop"

Prevents garments from slipping off of hangers. Packed 200

#MSLIPSTOP Clear  
#MSLIPSTOP/B Black



## Clear Garment "Kant Slip" Hanger Attachments

Packed 200  
#MKSLIPS



## Pressure Sensitive Foam Strips

Charcoal gray peel & strip. 1600 strips per roll.  
#MFOAM



## Adhesive Non-Slip Hanger Attachment

210 Per Pack  
#MSGRIP



## Foam Pad Hanger Covers

Keeps dresses and blouses from slipping. Fits most 16" to 18" hangers.

#MCHAR Charcoal  
#MWHT White

## Colored Markers

Snap on to hanger to denote style, delivery, dates or price.

**Colors Available:** White, Black, Bright Red, Dark Red, Sun Yellow, Light Yellow, Grass Green, Pink, Light Blue, Navy Blue, Orange, Beige, Dark Brown, Grey, Lilac, Salmon, Dark Turquoise, Light Turquoise.  
Packed 100



#MSNAP

## Chrome Finished Hanger Stacker

For dress, skirt and suit hangers

#MHSTKR

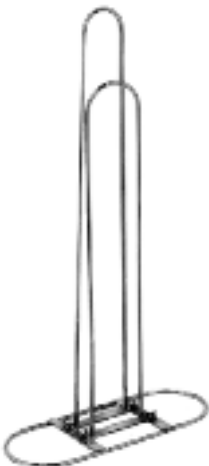

## Clear Plastic Hanger Connector

Single Loop  
Packed 100

#MHGRCON5



## Plastic Hanger Connector

9 Loop  
Packed 100

#MHGRCON 3



## Hanger Retrievers

Retrieve hangers from out of reach locations.



#MLIFTER  
54" Long

#MLIFTER2  
72" Long

# Steamers & Spot Removers

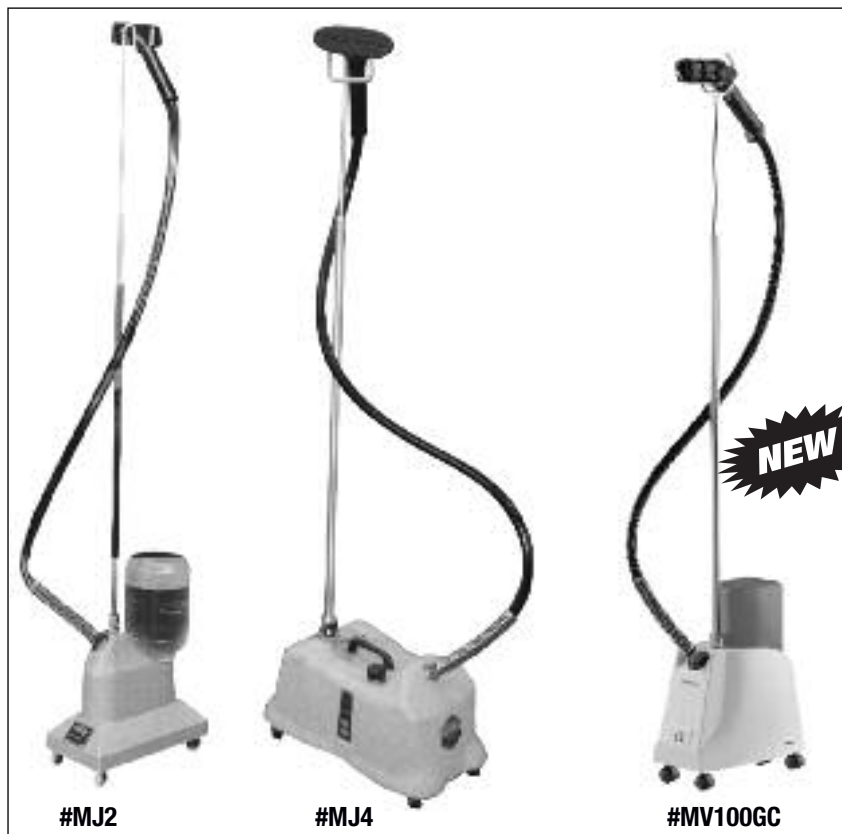

## Albatross Spot Removing Gun

Use with Everblum All-Purpose Cleaning Fluid. F.O.B. NY Only  
#MGUN



## Jiffy Hand Held Steamer

High capacity, uses tap water. Double insulated to be cool to the touch.

#MJ5



## Jiffy Steamer

1500 watts of output for higher steam production. Three position switch with preheat option. Available in 110 volt & 220 volt models

#MJ4

#MJ4/220 **Special Order**

## Jiffy Steamer

1350 watts of output, two position on-off switch. New stainless steel heating element resists corrosion. Available in 110 volt & 220 volt models

#MJ2

#MJ2/220 **Special Order**

## Reliable Steamer

1350 watts of output, is a professional grade garment steamer that is suitable for commercial or home use. The steam works by softening the fibers, allowing the fabric to relax.

#MV100GC

## Everblum All-Purpose Cleaning Fluid

#MGAL Gallon



## Jiffy Steamer Cleaning Solvent

10oz. Liquid Cleaner.  
#MJCL



## All Purpose Spray Spot Remover

5 oz Aerosol Can.  
#MSPRAY



## Cosmetic Spot Remover

8 oz can with applicator top.  
#MSPRAY2

## Jiffy Steamer Parts

#MJB	Replacement bottle for old MJ2
#MJB/NEW	Replacement bottle for new MJ2 (with check valve)
#MJCORD	Replacement electrical cord
#MJH	Hose assembly - Plastic head
#MJSWT	Rocker switch for MJ2
#MJUP	Hose Hanger Upright

# Pins & Supplies

## Dressmaker Pins

- #MD17 1 1/16" #17 Dressmaker Pins - 1lb.
- #MD20 1 1/4" #20 Dressmaker Pins - 1lb.
- #MD24 1 1/2" #24 Dressmaker Pins - 1lb.



## Bank Pins

- #MB17 1 1/16" #17 Bank Pins - 1lb.
- #MB20 1 1/4" #20 Bank Pins - 1lb.
- #MB24 1 1/2" #24 Bank Pins - 1lb.
- #MB28 1 3/4" #28 Bank Pins - 1lb.
- #MB32 2" #32 Bank Pins - 1lb.

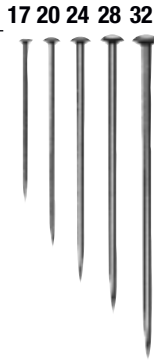

## Safety Pins

- 1 Gross = 144
- #MS00 3/4" Brass Open Safety Pin - pk 10 gross
  - #MS00BK 3/4" Black Open Safety Pin - pk 10 gross
  - #MS00C 3/4" Nickel Open Safety Pin - pk 10 gross
  - #MS1 1 1/16" #1 Closed Safety Pin - pk 10 gross
  - #MS2 1 1/2" #2 Closed Safety Pin - pk 720
  - #MS3 2" #3 Closed Safety Pin - pk 360

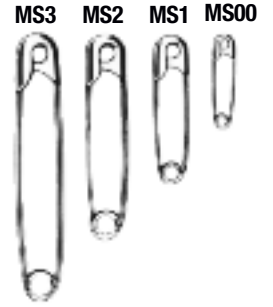

## Steel T-Pins

- #MT16 1" #16 T-pins - 1/2 lb.
- #MT20 1 1/4" #20 T-pins - 1/2 lb.
- #MT24 1 1/2" #24 T-pins - 1/2 lb.
- #MT28 1 3/4" #28 T-pins - 1/2 lb.
- #MT32 2" #32 T-pins - 1/2 lb.

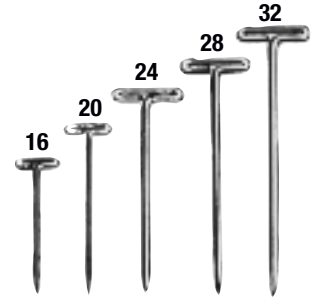

Not Shown at Actual Size.

### Economy Lint Roller

With 80 sheets  
of strip tape  
#MLINT/I



### Lint Roller

With 60 sheets  
of strip tape  
#MLINT



### Deluxe Handle

For use with lint refills  
#MLINT1H



### Lint Roller Refills

Pack of 12  
#MLINT1R



### Hygienic Panty Liners

Try-On protection for swim suits &  
intimate apparel. 1000/roll  
#MP/PL



### Hygienic Paper Panties

Try-On protection for swim suits &  
intimate apparel. Packed 25  
#MP/TP Junior  
#MP/BP Missy



### Make-up Masks

Protection from make-up  
on clothing. Packed 25  
#MP/MM



### Disposable Sock

Try-On Protection for foot.  
Packed 144  
#MP/DS

# Size Dividers

## A. Round Size Dividers



## B. Wrap Around Die Cut Adhesive Labels

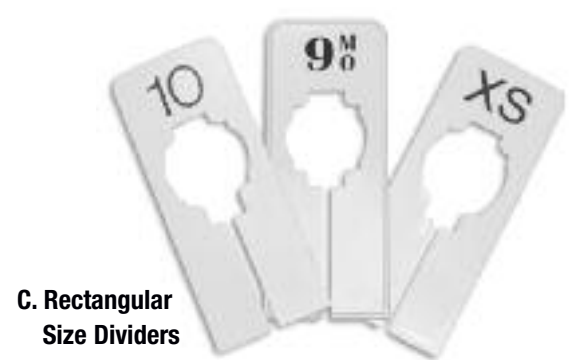
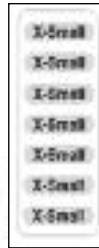

C. Rectangular Size Dividers

### A. Round Size Divider Fits up to $1\frac{5}{16}$ " Round Tubing.

Stock sizes available: numbers 1 thru 57, x-small, small, medium, large, x-large, xx-large, xxx-large, 3mo-24mo, blank.

Special order sizes available on 100 or more per size. Please inquire.

- #MSD1 White with Black Print (100 of a size)
- #MSD2 Black with Gold Print (100 of a size)

### B. $1\frac{1}{4}$ " x 5" Wrap Around Die Cut Adhesive Size Labels

Recommended for use on all folded merchandise.

Pressure sensitive clear label printed black on a white background.

Stock sizes available: X-Small thru XX-Large, Missy 2 thru 18, Junior 1 thru 15, Children's 4 thru 14.

- #TSDWRAP 250 per size, per roll

### C. 2" x 5" Rectangular Size Divider

To fit round, rectangular, or square tubing. White with black print.

Sizes available: Numbers 1 thru 57, x-small, small, medium, large, x-large, xx-large, xxx-large, 3mo-24mo & blank. Special order sizes available on 100 or more per size, please inquire.

- #MSD3 (100 of a size)

### D. $\frac{1}{2}$ " Adhesive Size Stickers

Stock sizes available: XS, S, M, L, XL as well in numbered sizes. Clear with Black Print.

- #TSIZE 1,000 per size, per roll

### E. Snap On Size Dividers

White with Black Print.

Sizes available: Numbers 1 thru 52, Petite, X-Small, Small, Medium, Large, X-Large, XX-Large, XXX-Large & Men's Suit sizes 33S thru 51L.

Special order sizes available on 100 or more per size, please inquire.

- #MSD4 Packed 25 per size.

### F. Snap On Color Codes

Colors Available: White, Black, Bright Red, Dark Red, Sun Yellow, Light Yellow, Grass Green, Dark Green, Pink, Light Blue, Navy Blue, Orange, Beige, Dark Brown, Gray, Dark Gray, Lilac, Salmon, Dark Turquoise, Light Turquoise.

Packed 100 per color

- #MSNAP

### G. $3\frac{1}{2}$ " x 9" Rectangular King Size Divider - Blank

- #MSD5 White

## D. Adhesive Size Stickers



## E. Snap On Size Dividers



## F. Snap On Color Codes



## G. King Size Divider



# Supplies



## Poly Vinyl Packing Tape

2" x 55 yard rolls

Packed 36

#MTAPE1 Tan

#MTAPE2 Clear

#MTAPED Dispenser Gun



## Lucite Folding Board

9 3/8" x 13 1/2"

Used to neatly fold garments to consistent sizes.

#MFOLD



## Shopping Basket

Blue Plastic with metal handles.

14"L x 9.5"W x 8.5"D

#MBASKET

## Hooks & Clips



### Swivel Utility Clip

Packed 100

#MCLIPW White

#MCLIPB Black



### Belt Hook

Black

Packed 100

#MBELT



### Tie Hook

Black

Packed 100

#MTIE



### Large Scarf Display Ring

Black

#MSCARF15



### "S" Shape Utility Hooks

Chrome

#MSHOOK3 3"

#MSHOOK4 4"



### Large Utility Clip

4" x 2 1/2" Packed 10

#MHANG/W White

#MHANG/B Black



### Plastic Suction Cup with Hook

#MSUC



### Plastic Track Hook

to fit drop ceiling channel

#MTRACK



### Stick-On Display Hook

Pressure Sensitive

Packed 200

#MSTICK5



### Stick-On Adhesive Tab

With closed hook

Packed 100

#MSTICK10



# Security Devices & Dump Bins

## 7" Security Cable Lock.

Stop the Grabber  
Fastens hanger to lock  
and prevents snatch-type  
shoplifting. Packed 1,000  
#TSECURD



## Showcase Lock

Ratchet Type  
#JLOCK



## Door Chime

Battery Operated  
#MDC41



## Security Cable

Ring and lock-chrome.  
#MSCB



## Simulated Security Camera

6¼" x 2¾" x 2¾" Weatherproof molded  
ABS plastic camera with flashing LED.  
Operates on 2 "AA" cells. Fully adjustable  
bracket. #SC2010

## Silver Hi Tech Simulated Security Camera

10" x 6" x 7" Weatherproof molded  
ABS plastic camera with flashing LED.  
Operates on 2 "AA" cells. Fully  
adjustable bracket. #SC2015

## Dome Simulated Security Camera

2¾"H x 4⅝" Dia. Ceiling Mounting  
camera with flashing LED.  
Operates on 2 "AA" cells.  
#SCDM7

## Convex Security Mirrors

All Convex Mirrors come with adjustable,  
removable mounting rod and hardware.

#MDR12	12" dia.
#MDR18	18" dia.
#MDR26	26" dia.
#MDR30	30" dia.

## Dressing Room Frame & Dump Bins

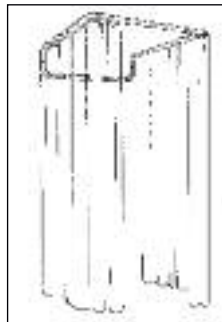

## Metal Shopping Cart - 60 Liter

18"W x 29"D x 38½"H  
With safety belt.  
#MSC/60L



## Low Cost Dressing Room Frame

Screws directly into wall. Black or White  
powdercoated finish. 48"W x 36"D

#WROOMB Black

#WROOMW White

(frame only, curtain not included)

Now Knock-down & UPS Shippable

## Dressing Room Numbers

Set of 6 cards in  
Orange, Neon Yellow, Mint,  
burgundy, Buff, Yellow

#MDN16



## Folding Dump Bin

Includes locking casters  
folds for easy storage.

#DJ48/C Chrome



# Salesman's Equipment



**Chrome Dress and Shirt Hanger**

Available in 12", 14", 16" & 18" widths.

- #HSM/910SB2 12" with loop
- #HSM/910SB4 14" with loop
- #HSM/910SB6 16" with loop
- #HSM/915SB 18" with loop
- #HSM/9106 16" without loop
- #HSM/915 18" without



**Chrome Pant and Skirt Hanger**

- #HSM/733SB 12" with loop
- #HSM/733 12" without loop



**Chrome Bikini Hanger**

- #HSM/275SB 12" with loop



**Chrome Suit Hanger**

Available in 14" & 16" widths.

- #HSM/920SB4 14" with loop
- #HSM/920SB6 16" with loop
- #HSM/9206 16" without loop



**Chrome Lingerie Hanger**

- #HSM/914SB 16" with loop
- #HSM/914 16" without loop

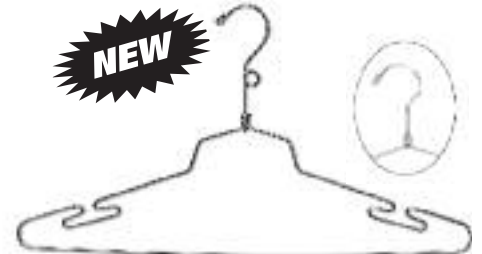

**Chrome Lingerie Hanger**

- #HSM/914SB-18 18" with loop
- #HSM/914-18 18" without loop

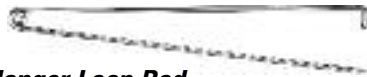

**Hanger Loop Rod**

Gang salesman's hanger with loop on one 15" loop rod. Use with Griptite and Strap-top bags for easier loading.

#HSM/DP



**White Rubber Coated Hanger**

- #HSM/1010SB 17" with loop



**Rolling Trunk Type Sample Cases**

30"H x 18"W

- #A12 12" Deep
- #A14 14" Deep

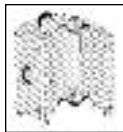

**Rolling Telescoping Type Sample Cases**

30"H x 18"W

- #A12T 12" Deep
- #A14T 14" Deep



**Rolling Trunk Type Sample Case with Hanging Bar**

36"H x 20"W

- #A36 12" Deep



**Replacement Wheel**

For rolling sample cases #A12, #A12T, #A14, #A14T & #A36 Hardware included.

#A14T/WHEEL



**Replacement Strap**

For rolling sample cases #A12T & #A14T

#ASTRAP/A14T

**Special Order**

# Salesman's Equipment

## Collapsible Salesman's Rack

48" Long with two 12" Pull-outs. Height adjusts to 65".

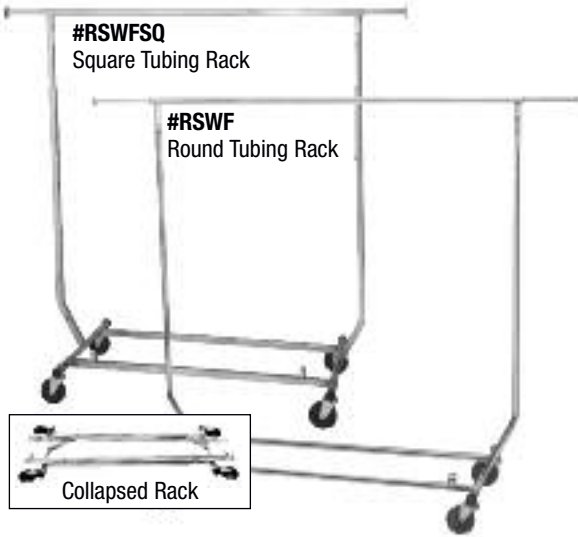

## Traveling Salesman's Screen

Attaches to standard folding rack with three brackets or folds flat to fit bottom. #RTS1

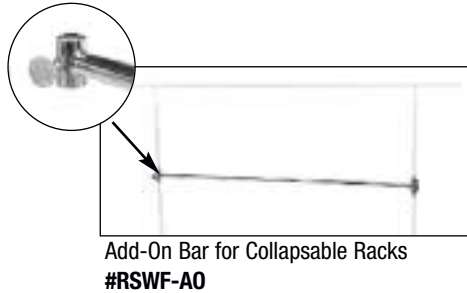

## 4" Ball bearing Caster

Replacement Caster with nut #M4C



## Griptite Sample Bags

15" bar to clamp metal salesman's hangers. Navy blue canvas.

### Heavy Canvas Material

#BG38*	38" long
#BG48*	48" long
#BG57	57" long
#BG66	66" long
#BG72	72" long

\* Also available in black

### Light Weight Nylon Material

#BG38N	38" long
#BG48N	48" long
#BG57N	57" long

## Strap-Top Sample Bags

Perfect for shirt line shown on all plastic hangers. Navy blue.

### Heavy Canvas Material

#BS38	38" long
-------	----------

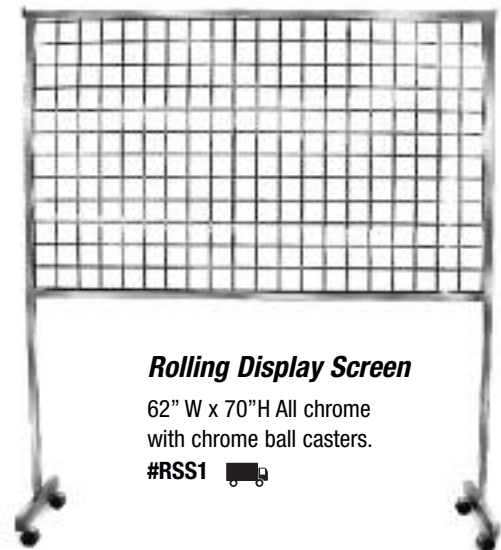

## Rolling Display Screen

62" W x 70" H All chrome with chrome ball casters.

#RSS1 

# Vinyl Suit & Dress Bags

**Full Length  
Flap-Over Bags**

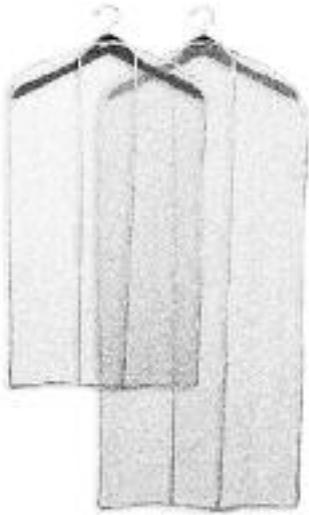

**Bridal Bag  
#V72Z**



**Gown Bag  
#VW72**



**Flap-Over Bags**

24" Wide, 2 Gauge Clear Vinyl

**Price per Dozen**

#V36F 36" Length

#V54F 54" Length

**Shoulder Covers**

Clear Vinyl

**Price per 100**

#V821002 Ladies 8" x 21" stitched-3 Gauge

#V821005 Ladies 8" x 21" heat sealed-4.5 Gauge

#V924002 Mens 9" x 24" stitched-2 Gauge

**Vinyl Shoulder  
Cover**



**Printed Garment Bags**

**Hot Stamping Foils:**

Beige	Light Pink	Matte Teal
Black	Burgundy	Metallic Teal
Dark Brown	Copper	Navy Blue
Purple	Dark Green	Orange
Grey	Gold	Red
White	Royal Blue	Hot Pink
Light Brown	Light Blue	Yellow
Light Green		

**One time plate charge\*: Call For Quote**

**Maximum Image Size: 6" x 6"**

**Allow 3-4 weeks delivery.**

\*No charge on Suit Bag orders over 500 Bags

**Zippered  
Suit Bag**



**Suit Bags - Zippered Price per 100**

24" Wide, 3 Gauge Vinyl

**40" Suit Bags**

#V40BLK	Black
#V40GRY	Grey
#V40CLR	Clear
#V40WHT	White
#V40BGE	Beige
#V40BKGL	Black/Gold Trim

**54" Suit Bags**

#V54BLK	Black
#V54GRY	Grey
#V54CLR	Clear
#V54WHT	White
#V54BGE	Beige
#V54BKGL	Black/Gold Trim

**Bridal Bags - Zippered Price per dozen**

72" Long, 3 Gauge Vinyl

with hanging document pocket

#V72Z Clear - 24" wide with 10" gusset

#VW72 White - 24" to 36" wide

# Low Cost Plastic Bags

## High Density Polyethylene Merchandise Bags

Item #	Size	Pk
#B69	6.5" X 9.5"	1000
#B911	8.5" X 11"	1000
#B121	12" X 15"	1000
#B123	12" X 3" X 18"	500
#B143	13" X 3" X 21"	500
#B174	16" X 4" X 24"	500
#B205	20" X 4" X 30"	500

Colors Available: Black, Pink, White and Yellow



## Zip Lock Jewelry Bags-2 Mil- Clear

Item #	Size	Pk Qty
#BJEWEL1	2" x 3"	100
#BJEWEL2	3" x 4"	100
#BJEWEL3	4" x 6"	100
#BJEWEL4	6" x 8"	100



## White Economy Weight High Density T-Shirt Handle Bags

Item #	Size	Pk
#B106WHT	10" X 5" X 19"	1000
#B127WHT	11.5" X 7" X 22"	1000
#B157WHT	15" X 7" X 25.5"	1000



## Leopard and Zebra Economy Weight High Density T-Shirt Handle Bags

Item #	Size	Pk Qty
#B126LEO	11.5" X 6" X 21"	500
#B8516LEO	8" X 5" X 16"	1000
#B126ZEB	11.5" X 6" X 21"	500
#B8516ZEB	8" X 5" X 16"	1000



## Self Sealing Multi-Purpose Packaging Bags- Clear

Item #	Size	Pk Qty
BSS/33	3" x 3" Self	100
BSS/35	3" x 5" Self	100
BSS/46	4" x 6" Self	100
BSS/69	6" x 9" Self	100
BSS/1216	12" x 16"	1000



# Stock Polyethylene Bags



Die Cut Handle Bags

## Stock Polyethylene Die Cut Handle Bags

Item #	Size	Pk Qty
#BSG9	9" x 12"	1000
#BSG12	12" x 15"	1000
#BSG15	15" x 18" x 4"	500
#BSG20	20" x 20" x 5"	500
#BSG24	24" x 24" x 5"	500

**Colors Available:** Black, Dusty Rose, Green, Red, White, Teal\* & Clear\*  
 (\*not available in BSG24)

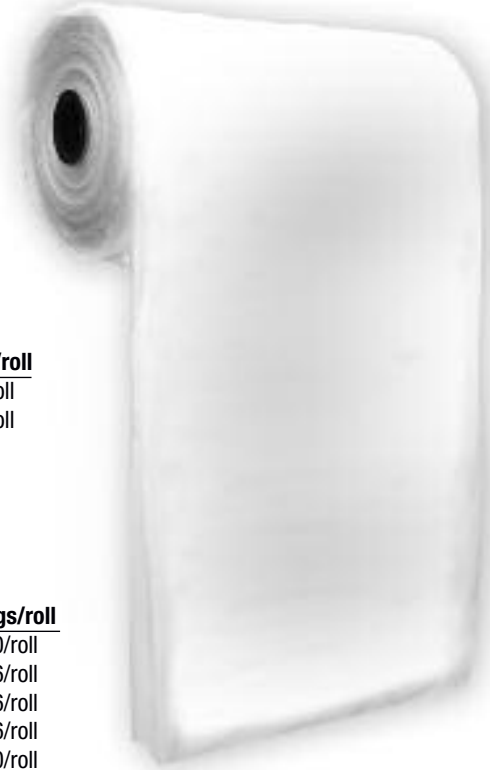

## Garment Poly Bags

20" Wide with 3" Gusset  
 Supreme Weight - 0.55 Mil

Price per roll

Item #	Color	Length	Bags/roll
#BR38	Clear	38" long	664/roll
#BR54	Clear	54" long	467/roll

## Garment Poly Bags

20" Wide with 3" Gusset  
 Supreme Weight - 1 Mil

Price per roll

Item #	Color	Length	Bags/roll
#BH36CLR	Clear	36" long	400/roll
#BH54B	Black	54" long	266/roll
#BH54CLR	Clear	54" long	266/roll
#BH54W	White	54" long	266/roll
#BH72CLR	Clear	72" long	200/roll
#BH72W	White	72" long	200/roll

Garment Poly Bags

## Bagging Units



**Bagging Jack**  
 #RBJ

**One Roll Bagging Unit**  
 #R1R

**Three Roll Bagging Unit**  
 #R3R

# Frosted Shopping & Merchandise Bags

## Die Cut Handle Merchandise Bags

Item #	Color	Size	Gauge	Pk Qty
#BHD912	Frosted Clear	9" x 12"	1.75 mil	1000
#BHD912	Black	9" x 12"	1.75 mil	1000
#BHD912	Lavender	9" x 12"	1.75 mil	1000
#BHD912	Pink	9" x 12"	1.75 mil	1000
#BHD1215	Frosted Clear	12" x 15"	1.75 mil	500
#BHD1215	Black	12" x 15"	1.75 mil	500
#BHD1215	Lavender	12" x 15"	1.75 mil	500
#BHD1215	Pink	12" x 15"	1.75 mil	500
#BHD143	Frosted Clear	14" x 3" x 21"	2 mil	500
#BHD143	Black	14" x 3" x 21"	2 mil	500
#BHD143	Green	14" x 3" x 21"	2 mil	500
#BHD143	Lavender	14" x 3" x 21"	2 mil	500
#BHD143	Pink	14" x 3" x 21"	2 mil	500

Die Cut Handle Merchandise Bags



## Rope Handle Shopping Bag with Cardboard Bottom

Item #	Color	Size	Gauge	Pk Qty
#BHDR85	Leopard	8" x 5" x 10"	3 mil	250
#BHDR1612	Leopard	16" x 6" x 12"	3 mil	250
#BHDR1612	Zebra	16" x 6" x 12"	3 mil	250

Rope Handle Shopping Bag

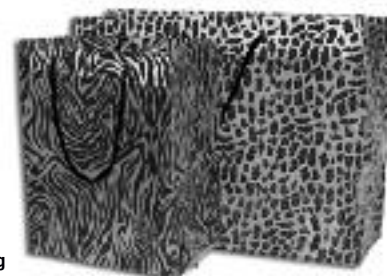

## Soft Loop Handle Shopping Bag with Cardboard Bottom

Item #	Color	Size	Gauge	Pk Qty
#BHD53	Frosted Clear	5" x 3" x 7"	3 mil	250
#BHD53	Black	5" x 3" x 7"	3 mil	250
#BHD53	Lavender	5" x 3" x 7"	3 mil	250
#BHD53	Pink	5" x 3" x 7"	3 mil	250
#BHD53	Leopard	5" x 3" x 7"	3 mil	250
#BHD53	Zebra	5" x 3" x 7"	3 mil	250
#BHD85	Frosted Clear	8" x 5" x 10"	3 mil	250
#BHD85	Black	8" x 5" x 10"	3 mil	250
#BHD85	Blue	8" x 5" x 10"	3 mil	250
#BHD85	Lavender	8" x 5" x 10"	3 mil	250
#BHD85	Pink	8" x 5" x 10"	3 mil	250
#BHD85	Leopard	8" x 5" x 10"	3 mil	250
#BHD85	Zebra	8" x 5" x 10"	3 mil	250
#BHD1612	Frosted Clear	16" x 6" x 12"	3 mil	250
#BHD1612	Black	16" x 6" x 12"	3 mil	250
#BHD1612	Blue	16" x 6" x 12"	3 mil	250
#BHD1612	Green	16" x 6" x 12"	3 mil	250
#BHD1612	Pink	16" x 6" x 12"	3 mil	250
#BHD1612	Leopard	16" x 6" x 12"	3 mil	250
#BHD1612	Zebra	16" x 6" x 12"	3 mil	250
#BHD1616	Frosted Clear	16" x 6" x 16"	3 mil	250
#BHD1616	Black	16" x 6" x 16"	3 mil	250
#BHD1616	Pink	16" x 6" x 16"	3 mil	250

Gem



Cub



Vogue



Classic

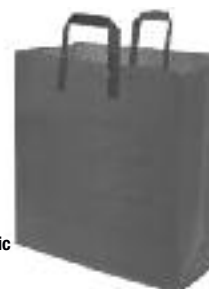

See Inside Back Cover for Color Samples

# Paper Shopping Bags



## White Kraft

Item #	Size		Pk Qty
#BKB/5	5 1/2" x 3 1/4" x 8 1/4"	Gem	250
#BKB/10	8" x 4 3/4" x 10 1/4"	Cub	250
#BKB/15	10" x 5" x 10"	Mister	250
#BKB/20	16" x 6" x 12"	Vogue	250
#BKB/30	16" x 6" x 16"	Classic	200
#BKB/50	18" x 7" x 18"	Jumbo	200



Gem

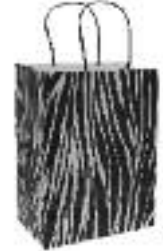

Cub



Mister



Vogue



Classic



Jumbo

## Brown Kraft

Item #	Size		Pk Qty
#BKB/5KFT	5 1/2" x 3 1/4" x 8 1/4"	Gem	250
#BKB/10KFT	8" x 4 3/4" x 10 1/4"	Cub	250
#BKB/15KFT	10" x 5" x 10"	Mister	250
#BKB/20KFT	16" x 6" x 12"	Vogue	250
#BKB/30KFT	16" x 6" x 16"	Classic	200
#BKB/50KFT	18" x 7" x 18"	Jumbo	200

## Brown Kraft Tint

Item #	Size		Pk Qty
#BKB/5T	5 1/2" x 3 1/4" x 8 1/4"	Gem	250
#BKB/10T	8" x 4 3/4" x 10 1/4"	Cub	250
#BKB/20T	16" x 6" x 12"	Vogue	250

Colors Available: Black Tint & Chocolate Tint

See Inside Back Cover for Color Samples

## Brown Kraft Illusion Groove

Item #	Size		Pk Qty
#BKB/10IG	8" x 4 3/4" x 10 1/4"	Cub	250
#BKB/20IG	16" x 6" x 12"	Vogue	250

## Zebra & Leopard Print

Item #	Size		Pk Qty
#BKB/10ZEB	8" x 4 3/4" x 10 1/4"	Cub	250
#BKB/20ZEB	16" x 6" x 12"	Vogue	250
#BKB/10LEO	8" x 4 3/4" x 10 1/4"	Cub	250
#BKB/20LEO	16" x 6" x 12"	Vogue	250



# High Quality Paper Bags

## High Quality Colored Paper Shopping Bags *Natural Pinstripe Tint*

See Inside Back Cover for Color Samples

Item #		Size	Pk Qty
#BK10NT/FCB	French Country Blue	8" x 4 <sup>3</sup> / <sub>4</sub> " x 10 <sup>1</sup> / <sub>2</sub> "	250
#BK10NT/MY	Mellow Yellow	8" x 4 <sup>3</sup> / <sub>4</sub> " x 10 <sup>1</sup> / <sub>2</sub> "	250
#BK10NT/SG	Sage Green	8" x 4 <sup>3</sup> / <sub>4</sub> " x 10 <sup>1</sup> / <sub>2</sub> "	250
#BK10NT/TC	Terra Cotta	8" x 4 <sup>3</sup> / <sub>4</sub> " x 10 <sup>1</sup> / <sub>2</sub> "	250
#BK20NT/FCB	French Country Blue	16" x 6" x 13"	250
#BK20NT/MY	Mellow Yellow	16" x 6" x 13"	250
#BK20NT/SG	Sage Green	16" x 6" x 13"	250
#BK20NT/TC	Terra Cotta	16" x 6" x 13"	250
#BK40NT/FCB	French Country Blue	16" x 6" x 19 <sup>1</sup> / <sub>2</sub> "	200
#BK40NT/MY	Mellow Yellow	16" x 6" x 19 <sup>1</sup> / <sub>2</sub> "	200
#BK40NT/SG	Sage Green	16" x 6" x 19 <sup>1</sup> / <sub>2</sub> "	200
#BK40NT/TC	Terra Cotta	16" x 6" x 19 <sup>1</sup> / <sub>2</sub> "	200

### Precious Metals

Item #		Size	Pk Qty
#BK10PM/CP	Copper Penny	8" x 4 <sup>3</sup> / <sub>4</sub> " x 10 <sup>1</sup> / <sub>2</sub> "	250
#BK10PM/GR	Gold Rush	8" x 4 <sup>3</sup> / <sub>4</sub> " x 10 <sup>1</sup> / <sub>2</sub> "	250
#BK10PM/HHS	Hi Ho Silver	8" x 4 <sup>3</sup> / <sub>4</sub> " x 10 <sup>1</sup> / <sub>2</sub> "	250
#BK20PM/CP	Copper Penny	16" x 6" x 13"	250
#BK20PM/GR	Gold Rush	16" x 6" x 13"	250
#BK20PM/HHS	Hi Ho Silver	16" x 6" x 13"	250
#BK40PM/CP	Copper Penny	16" x 6" x 19 <sup>1</sup> / <sub>2</sub> "	200
#BK40PM/GR	Gold Rush	16" x 6" x 19 <sup>1</sup> / <sub>2</sub> "	200
#BK40PM/HHS	Hi Ho Silver	16" x 6" x 19 <sup>1</sup> / <sub>2</sub> "	200



## Recyclable High Quality Paper Merchandise Bags



Item #	Color	Size	Pk Qty
#BP69BK	Black	6 <sup>1</sup> / <sub>4</sub> " x 9 <sup>1</sup> / <sub>4</sub> "	1000
#BP69G	Gray	6 <sup>1</sup> / <sub>4</sub> " x 9 <sup>1</sup> / <sub>4</sub> "	1000
#BP69KFT	Kraft	6 <sup>1</sup> / <sub>4</sub> " x 9 <sup>1</sup> / <sub>4</sub> "	1000
#BP69P	Pink	6 <sup>1</sup> / <sub>4</sub> " x 9 <sup>1</sup> / <sub>4</sub> "	1000
#BP69W	White	6 <sup>1</sup> / <sub>4</sub> " x 9 <sup>1</sup> / <sub>4</sub> "	1000
#BP911BK	Black	8 <sup>1</sup> / <sub>2</sub> " x 11"	1000
#BP911G	Gray	8 <sup>1</sup> / <sub>2</sub> " x 11"	1000
#BP911KFT	Kraft	8 <sup>1</sup> / <sub>2</sub> " x 11"	1000
#BP911P	Pink	8 <sup>1</sup> / <sub>2</sub> " x 11"	1000
#BP911W	White	8 <sup>1</sup> / <sub>2</sub> " x 11"	1000
#BP123BK	Black	12" x 2 <sup>3</sup> / <sub>4</sub> " x 18"	500
#BP123G	Gray	12" x 2 <sup>3</sup> / <sub>4</sub> " x 18"	500
#BP123KFT	Kraft	12" x 2 <sup>3</sup> / <sub>4</sub> " x 18"	500
#BP123P	Pink	12" x 2 <sup>3</sup> / <sub>4</sub> " x 18"	500
#BP123W	White	12" x 2 <sup>3</sup> / <sub>4</sub> " x 18"	500
#BP143BK	Black	14" x 3" x 21"	500
#BP143G	Gray	14" x 3" x 21"	500
#BP143KFT	Kraft	14" x 3" x 21"	500
#BP143P	Pink	14" x 3" x 21"	500
#BP143W	White	14" x 3" x 21"	500
#BP174BK	Black	16" x 3 <sup>3</sup> / <sub>4</sub> " x 24"	500
#BP174G	Gray	16" x 3 <sup>3</sup> / <sub>4</sub> " x 24"	500
#BP174KFT	Kraft	16" x 3 <sup>3</sup> / <sub>4</sub> " x 24"	500
#BP174P	Pink	16" x 3 <sup>3</sup> / <sub>4</sub> " x 24"	500
#BP174W	White	16" x 3 <sup>3</sup> / <sub>4</sub> " x 24"	500

# Custom Printed Bags

## One of the the most effective ways to advertise your store name and product!

Having an eye-catching shopping bag allows a business to effectively and inexpensively advertise. When your customer carries your banner, other shoppers observe your company's name and interpret it as an endorsement. It is why car dealers provide you with a license plate frame for your car...free advertising and immediate endorsement. *In most cases you're going to provide a bag anyway; personalizing is a small percentage of the cost of the bag.*

## General Guidelines

### Artwork:

Artwork must be provided as an electronic file. Artwork must be saved as an .ai, .eps or a .pdf file, must be created (not placed) in Adobe Illustrator, with all fonts outlined or included.

### Plates & Dies:

The plate or die charge is usually determined by the total number of square inches occupied by your art. Other variables such as multiple colors and complexity of design will also affect the cost. Consequently, plate charges cannot be quoted until your artwork has been sized and approved.

### Print or Hot Stamp:

Paper and Frosted Shopping Bags can be printed with ink or hot stamped with a foil. All other bag materials; Polyethylene, Supergloss & Bags on Rolls can only be printed.

## Supergloss Bags

### Quantity

The minimum order for printed Supergloss bags is 6,000\* bags per size.  
\*Please allow a 25% over/under run.

### Delivery Time

The printing of your bags takes approximately 4-6 weeks from proof approval.



## Ink & Bag Colors

### For Supergloss, Polyethylene and Bags on Rolls

#### Ink Colors:

White, Yellow-#012, Sun Yellow-#123, Orange-#021, Red-#185, Fire Red-#485, Maroon-#208, Pink-#219, Purple-#253, Pantone Violet, Royal Blue-#286, Navy Blue-#295, Light Blue-#299, Sky Blue-#305, Reflex Blue, Teal-#326, Emerald Green-#334, Forest Green-#343, Kelly Green-#348, Slate Grey-#424, Brown-#483, Metallic Silver-#877, Metallic Copper-#876, Black, 18k Gold

#### Custom PMS Ink:

Call for Quote and Pricing.

#### Bag Colors:

**Group 1:** Beige, Black, Buff, Clear, Dark Blue, Dark Green, Light Ivory, Ivory, Pearl Grey, Red, Teal, White, Yellow

**Group 2:** Burgundy, Citrus Green, Dusty Rose, Gold, Purple, Light Blue, Magenta, Navy Blue, Silver

#### Over/Under Run:

Custom printed orders are subject to a 25% quantity Over/Under Run.  
Printed bags on rolls are subject to a 20% quantity Over/Under Run.  
(ie. Order 5,000 bags, you may receive between 3,750 & 6,250 bags.)

## Polyethylene Bags

### Quantity

The minimum order for printed polyethylene bags is 6,000\* bags per size.  
\*Please allow a 15% over/under run.

### Delivery Time

The printing of your bags takes approximately 4-6 weeks from proof approval.



# Bags On Rolls

## Quantity

The minimum order for printed polyethylene bags on rolls is 5 rolls per size.

## Plate

Please call for plate Price. Each color requires it's own plate.

## Delivery Time

The printing of your bags takes approximately 4-6 weeks from proof approval.

Bag Size	Bag Rolls	Impressions Per Bag
21" x 3" x 40"	450	1,2
21" x 3" x 54"	333	1, 3
21" x 3" x 72"	250	2, 3, 4



# Paper Shopping Bags

## Quantity

The minimum order for Printed/Hot Stamped bags is 1,000 bags per size, a Short Run. More intricate artwork requires a 5,000 bag minimum, a Mill Run.

The Short Run is ideal for simple 1 & 2 color artwork. The Mill Run allows for complex designs, gusset printing and multi-colored artwork.

## Delivery Time

The Printing or Hot Stamping of your bags takes approximately 4-6 weeks from proof approval.



## Paper Bag Colors

**Natural Kraft Tints:** Black, Hunter Green, Navy Blue, Colonial Red, Teal, Purple, Burgundy, Chocolate, Cinnamon, Xmas Red, Olive.

**White Kraft Tints:** Primary Green, Primary Red, Mint Green, Pastel Yellow, Pastel Blue, Pastel Pink, Black.

**Gloss Tints:** Black, White, Red, Ivory, Hunter Green, Yellow.

**Natural Kraft Gingham:** Green, Red, Navy Blue.

## Stock Foils

### Metallics Foils

Red, Copper, Green, Apple Green, Purple, Silver, Gold, Fuchsia, Blue, Teal

### Matte Metallic Foils

Copper, Pearlized, Blue, Gold, Silver

### Matte Pigment Foils

Black, Red, Navy Blue, Electric Blue, Burgundy, Deep Pink, Light Pink, Purple, Bright Yellow, Dark Green, Ivory, White, Brown, Orange

## Stock Inks

Black, Dark Red - PMS #199, Purple - PMS #526, Reflex Blue, Burgundy - PMS #209, Dark Teal - PMS #322, Teal - PMS #327, Brown - PMS #490, Rhodamine Red, Dark Green - PMS #560, Navy Blue - PMS #294, Cinnamon - PMS #174, Grass Green - PMS #354, Orange - PMS #021, Copper - PMS #294\*, Gold - PMS #873\*, Silver - PMS #877\*

### Custom PMS Ink per Order

\*Metallic inks Upcharge per Order

# Price Tags



#T363NS

White Tag w/Blue Lettering  
2 3/8" x 4 3/4"

#T362NS

White Tag w/Red Lettering  
2 3/8" x 4 3/4"

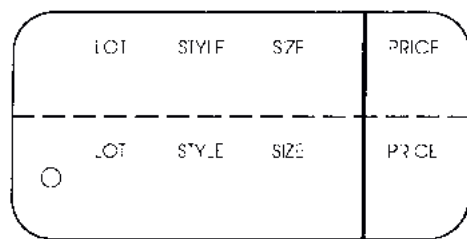

#T49NS

2 7/8" x 1 3/8"

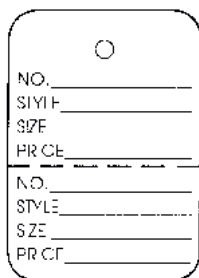

#T59NS

1 1/4" x 1 7/8"

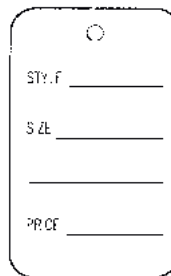

#T30NS

1 1/4" x 1 7/8"



#T31NS

1 3/4" x 2 7/8"

## White Price Tags

Item #		Pack/Qty
#T30NS	No String	1,000
#T30S	String	1,000
#T31NS	No String	1,000
#T362NS	No String	1,000
#T363NS	No String	1,000

## Jewelry Tags

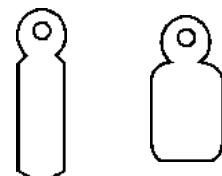

#T78J

7/8" x 1/4"

#T85J

7/16" x 13/16"

with burgundy string.  
Packed 1,000

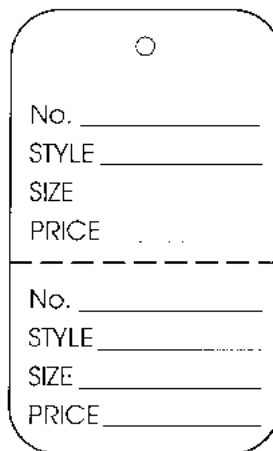

#T37NS

1 3/4" x 2 7/8"

## Color Price Tags

Item #		Pack/Qty
#T37NS	No String	1,000
Available in: Blue, Grey, Green, Lavender, Light Blue, Orange, Pink, Red, White, Yellow		
#T37S	String	1,000
Available in: White		
#T49NS	No String	1,000
Available in: White, Blue, Buff, Green, Grey, Lavender, Light Blue, Orange, Pink, Yellow		
#T59NS	No String	1,000
Available in: Green, Grey, Lavender, Light Blue, Orange, Pink, Red, White, Yellow		
#T59S	String	1,000
Available in: White, Blue, Buff, Grey, Lavender, Light Blue, Orange, Pink, Red, Yellow		

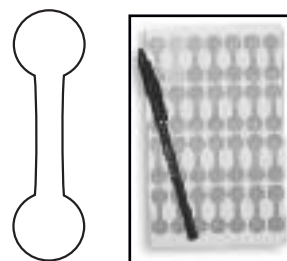

"Dumbbell" Adhesive Jewelry Tags  
1 3/8" x 1/2"

Item #	Color	Pack/Qty
#TKB2107	White	1,000
#TKB2107G	Gold	1,000
#TKB2107S	Silver	1,000

# Sale Price Tags



**#T367NS- No String**  
White Tag w/Red Lettering  
Actual Size 2<sup>7</sup>/<sub>8</sub>" x 1<sup>3</sup>/<sub>4</sub>"  
Packed 1,000



**#T368NS- No String**  
**#T368S- String**  
Red Tag w/Yellow Lettering  
Actual Size 2<sup>7</sup>/<sub>8</sub>" x 1<sup>3</sup>/<sub>4</sub>"  
Packed 1,000



**#T801NS- No String**  
**#T801S- String**  
Red Tag w/White Lettering  
Actual Size 1<sup>1</sup>/<sub>4</sub>" x 1<sup>1</sup>/<sub>8</sub>"  
Packed 1,000



**#T366NS- No String**  
**#T366S- String**  
Red Tag w/Yellow Lettering  
Actual Size 1<sup>1</sup>/<sub>4</sub>" x 1<sup>1</sup>/<sub>8</sub>"  
Packed 1,000



**#T310NS- No String**  
**#T310S- String**  
White Tag w/Red Lettering  
Actual Size 2" x 3<sup>1</sup>/<sub>2</sub>"  
Packed 1,000



**#T427NS- No String**  
White Tag w/Red Lettering  
Actual Size 2<sup>7</sup>/<sub>8</sub>" x 1<sup>3</sup>/<sub>4</sub>"  
Packed 1,000



**#T426NS- No String**  
White Tag w/Red Lettering  
Actual Size 1<sup>1</sup>/<sub>4</sub>" x 1<sup>1</sup>/<sub>8</sub>"  
Packed 1,000

# Price Tags

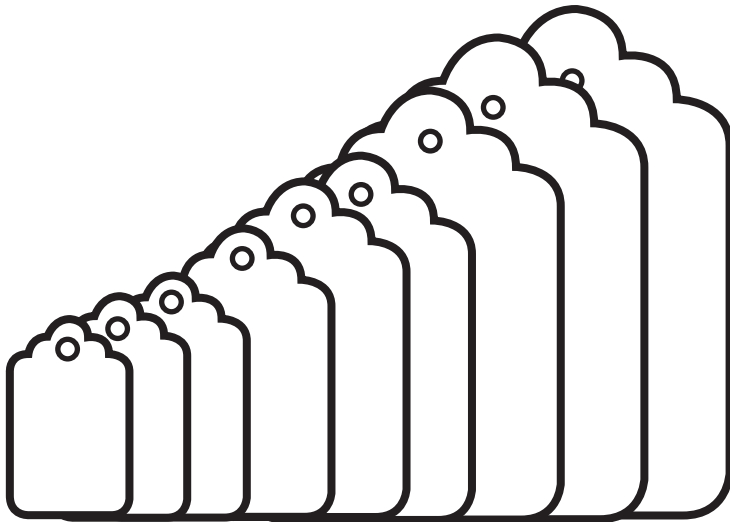

T1NS T2NS T3NS T4NS T5NS T6NS T7NS T8NS T9NS  
T1S T2S T3S T4S T5S T6S T7S T8S T9S

### Price per 1,000

#T1NS	5/8" x 1 1/16"	No String
#T1S	5/8" x 1 1/16"	String
#T2NS	3/4" x 1 1/8"	No String
#T2S	3/4" x 1 1/8"	String
#T3NS	7/8" x 1 1/4"	No String
#T3S	7/8" x 1 1/4"	String
#T4NS	15/16" x 1 1/2"	No String
#T4S	15/16" x 1 1/2"	String
#T5NS	1 1/16" x 1 3/4"	No String
#T5S	1 1/16" x 1 3/4"	String
#T6NS	1 1/4" x 1 15/16"	No String
#T6S	1 1/4" x 1 15/16"	String
#T7NS	1 7/16" x 2 1/4"	No String
#T7S	1 7/16" x 2 1/4"	String
#T8NS	1 11/16" x 2 3/4"	No String
#T8S	1 11/16" x 2 3/4"	String
#T9NS	2" x 3 1/4"	No String
#T9S	2" x 3 1/4"	String

# Adhesive Tags

Packs of 500



White & Red Tag  
Actual Size 1 5/8" x 1 1/8"  
#TPS74



White & Red Tag  
Actual Size 1 5/8" x 1 1/8"  
#TDP977



White & Red Tag  
Actual Size 1 5/8" x 1 1/8"  
#TDP978



White & Red Tag  
Actual Size 1 1/8" x 1 5/8"  
#TPS73



White & Red Tag  
Actual Size 1" Diameter  
#TPSR64



White & Red Tag  
Actual Size 1" Diameter  
#TPSR61



White & Red Tag  
Actual Size 1" Diameter  
#TPSR65

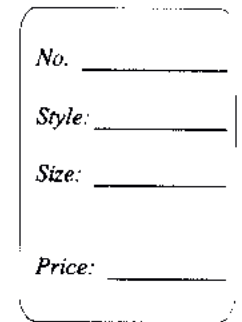

White & Red Tag  
Actual Size 1 1/8" x 1 5/8"  
#TPS75

### Blank Adhesive Tags

Item	Size		QTY/PK
A. #TR1212	3/4"	Round	1,015
B. #TO806	1/2" x 3/8"	Oval	1,001
C. #TR808	1/2"	Round	1,050
D. #TS508	5/16" x 1/2"	Rectangle	1,000
E. #TS610	3/8" x 5/8"	Rectangle	1,008
F. #TS812	1/2" x 3/4"	Rectangle	1,000
G. #TS1216	3/4" x 1"	Rectangle	1,000
H. #TS816	1/2" x 1"	Rectangle	1,015
I. #TS828	1/2" x 1 3/4"	Rectangle	840

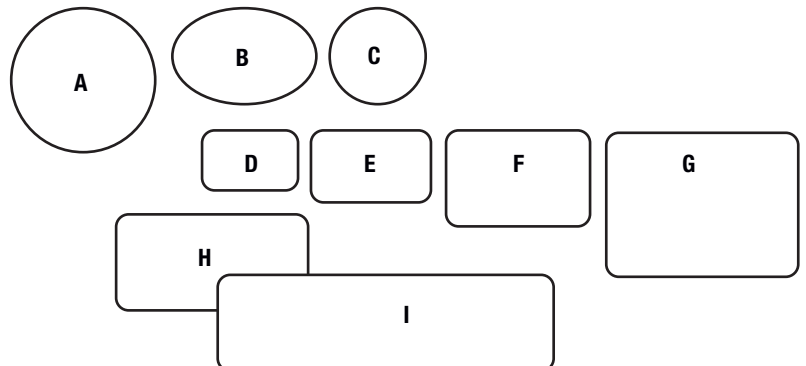



# Hand Labelers

## Single Line Sato/Dennison Hand Labeler

6 Character Gun,  
Labels: 1/2" x 3/8"  
#T106L



#T106A

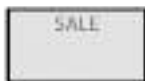

#T106B



#T106C

### Labels To Fit T106L Gun

Item #		Pack/Qty
#T106A	Blank White Label	9,000
#T106B	Yellow Sale Price	9,000
#T106C	Blank Red Label	9,000

## Two Line Sato/Dennison Hand Labeler

8 Character Gun,  
Labels: 3/4" x 5/8"  
#T216L



#T216A

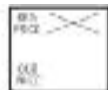

#T216B



#T216C



#T216D

### Labels To Fit T216L Gun

Item #		Pack/Qty
#T216A	Blank White Label	12,500
#T216B	Reg Price/Our Price	12,500
#T216C	Yellow Sale Price	12,500
#T216D	Blank Fluorescent	12,500

## Two Line Sato/Dennison Hand Labeler

10 Character Gun,  
Labels: 7/8" x 5/8"  
#T210L



#T210A



#T210B



#T210C



#T210D

### Labels To Fit T210L Gun

Item #		Pack/Qty
#T210A	Blank White Label	10,000
#T210B	Reg Price/Our Price	10,000
#T210C	Yellow Sale Price	10,000
#T210D	Blank Fluorescent	10,000

## Single Line Hand Labeler

8 Character Gun,  
Labels: 3/4" x 1/2"  
#T5500



**LOW COST**



#T5500A



#T5500B



#T5500C



#T5500D

### Labels To Fit T5500L Gun

Item #		Pack/Qty
#T5500A	White Label	5,000
#T5500B	Yellow Label	5,000
#T5500C	Flourescent Red	5,000
#T5500D	Flourescent Green	5,000

## Two Line Hand Labeler

10 Character Gun,  
Labels: 7/8" x 5/8"  
#T6600



**NEW ITEM**



#T6600A



#T6600B



#T6600C



#T6600D

### Labels To Fit T6600 Gun

Item #		Pack/Qty
#T6600A	Blank White Label	5,000
#T6600B	Fluorescent Yellow	5,000
#T6600C	Fluorescent Red	5,000
#T6600D	Fluorescent Green	5,000

## Replacement Inks

#T5500/INK For T5500 Labeler

#T6600/INK For T6600 Labeler



**NEW ITEM**

## Replacement Inks

#TINK1 For T106 Labeler

#TINK2 For T210 & T216 Labelers





# Tagging Guns & Fasteners

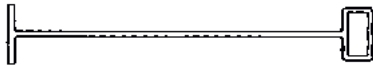

## Regular Swiftattachments - Clear

Item #	Size	Per Pack
#TMARK2F	1/2"	5,000
#TMARK22	1"	5,000
#TMARK2E	2"	5,000
#TMARK23	3"	5,000

## Regular Swiftattachments - Colors



Item #	Size	Color	Pack/Qty
#TMARK2EBK	2"	Black	5,000
#TMARK23BLU	3"	Blue	5,000
#TMARK23GRN	3"	Green	5,000
#TMARK23RED	3"	Red	5,000
#TMARK23YEL	3"	Yellow	5,000



## Fine Swiftattachments - Clear

Item #	Size	Pack/Qty
#TMARK27	3/4"	5,000
#TMARK28	2"	5,000

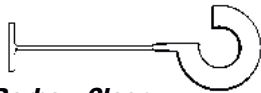

## Hook Barbs - Clear

#TTACH45  
2" Hook Barbs. Pk 5,000



## Securatach Fastners

Item #	Size	Pack/Qty
#TSECURA	3"	5,000
#TSECURB	5"	5,000
#TSECURC	9"	5,000

## Replacement Needles

- #TMARK21 5 PK  
For TMARK20 & TTACHOB
- #TMARK26 5 PK  
For TMARK25 gun only
- #T10001 4 PK  
For T10000 gun only
- #TTACH1 5 PK  
For Other regular guns only



#TMARK20  
Regular Needle  
Dennison Gun



#TMARK25  
Fine Needle  
Dennison Gun



#TTACHOB  
Regular Needle  
Arrow Gun

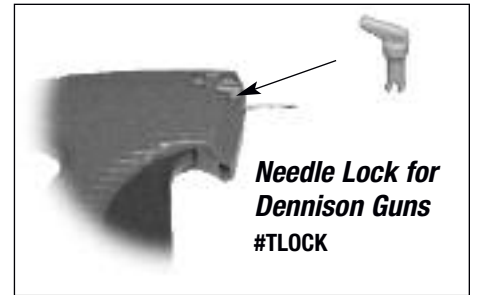

**Needle Lock for  
Dennison Guns**  
#TLOCK



## High Capacity Dennison Gun

Holds roll of 1,000 fasteners.  
Eliminates frequent reloading.  
#T10000 Regular needle only

## High Capacity Swiftattachments

Item#	Size	Pack/Qty
#T10002	1"	1,000
#T10003	2 1/2"	1,000



# Carbonless Sales & Business Forms



#D5A200

**Low Cost Duplicate Sales Forms With Carbon**

Item#	Size	Pk/Qty
#D5A200	5" x 3 1/4"	10

**Stock Carbonless Sales Forms**



#D5L240  
#D5L250

Item #	Size	Pk/Qty
#D5L240 Duplicate	3 5/8" x 6 3/8"	50
#D5L250 Triplicate	3 5/8" x 6 3/8"	50



#D5L527  
#D5L528

Item #	Size	Pk/Qty
#D5L527 Duplicate	4 1/4" x 6 1/2"	50
#D5L528 Triplicate	4 1/4" x 6 1/2"	50



#D1L146  
#D1L147

**Purchase Order Forms-Carbonless**

Item #	Size	Pk/Qty
#D1L146 Duplicate	8 1/2" x 11"	50
#D1L147 Triplicate	8 1/2" x 11"	50



#D5L320

Item #	Size	Pk/Qty
#D5L320 Duplicate	5 1/2" x 8"	50



#D5L350  
#D5L500

Item #	Size	Pk/Qty
#D5L350 Duplicate	5 1/2" x 8"	50
#D5L500 Triplicate	5 1/2" x 8"	50



#D7L787

**Credit Memo Form**

Item #	Size	Pk/Qty
#D7L787 Duplicate	8" x 5 1/2"	50



#D98002

**Gift Certificate**

Item #	Size	Pk/Qty
#D98002 Duplicate	8 1/2" x 3 3/4"	25

# Hanger Accessories

## Hanger "Slip Stop"

Prevents garments from slipping off of hangers. Packed 200

- #MSLIPSTOP Clear
- #MSLIPSTOP/B Black



## Clear Garment "Kant Slip" Hanger Attachments

Packed 200  
#MKSLIPS



## Pressure Sensitive Foam Strips

Charcoal gray peel & strip.  
1600 strips per roll.  
#MFOAM



## Adhesive Non-Slip Hanger Attachment

210 Per Pack  
#MSGRIP



## Foam Pad Hanger Covers

Keeps dresses and blouses from slipping. Fits most 16" to 18" hangers.

- #MCHAR Charcoal
- #MWHT White

## Colored Markers

Snap on to hanger to denote style, delivery, dates or price.

**Colors Available:** White, Black, Bright Red, Dark Red, Sun Yellow, Light Yellow, Grass Green, Pink, Light Blue, Navy Blue, Orange, Beige, Dark Brown, Grey, Lilac, Salmon, Dark Turquoise, Light Turquoise.  
Packed 100



#MSNAP

## Chrome Finished Hanger Stacker

For dress, skirt and suit hangers

#MHSTKR

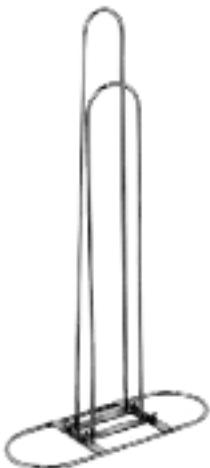

## Clear Plastic Hanger Connector

Single Loop  
Packed 100  
#MHGRCON5



## Plastic Hanger Connector

9 Loop  
Packed 100  
#MHGRCON 3



## Hanger Retrievers

Retrieve hangers from out of reach locations.



#MLIFTER  
54" Long

#MLIFTER2  
72" Long

# Apparel & Gift Boxes

## Apparel Boxes

### White Frost

Item #	Size	Packed
#Z35WA	10" x 7" x 1 1/4"	100
#Z46WA	11" x 8 1/2" x 1 5/8"	100
#Z77WA	15" x 9 1/2" x 2"	100
#Z80WA	17" x 11" x 2 1/2"	50
#Z85WA	19" x 12" x 3"	50
#Z105WA	24" x 14" x 4"	25

### Recycled Kraft Pinstripe

Item #	Size	Packed
#Z46BKRFT	11" x 8 1/2" x 1 5/8"	100
#Z77BKRFT	15" x 9 1/2" x 2"	100
#Z80BKRFT	17" x 11" x 2 1/2"	50
#Z85BKRFT	19" x 12" x 3"	50
#Z105BKRFT	24" x 14" x 4"	25

White Alligator



Kraft Pinstrip



Gift Boxes

## Gift Boxes

### White Varnish

Item #	Size	Packed
#Z102WA	2" x 2" x 2"	200
#Z103WA	3" x 3" x 2"	100
#Z107WA	7" x 7" x 7"	100
#Z111WA	4" x 4" x 4"	100
#Z112WA	5" x 5" x 3"	100
#Z113WA	6" x 6" x 4"	100
#Z114WA	6" x 6" x 6"	100
#Z115WA	6" x 4 1/2" x 4 1/2"	100
#Z119WA	9" x 4 1/2" x 4 1/2"	100
#Z120WA	8" x 8" x 3 1/2"	100
#Z122WA	8" x 8" x 8 1/2"	50
#Z124WA	10" x 10" x 6"	50
#Z131WA	12" x 6" x 6"	50
#Z180WA	3" x 3" x 3"	100
#Z181WA	4" x 4" x 2"	100
#Z183WA	10" x 5" x 4"	100
#Z186WA	14" x 6" x 6"	50

### Brown Kraft

Item #	Size	Packed
#Z102BKRFT	2" x 2" x 2"	200
#Z111BKRFT	4" x 4" x 4"	100
#Z112BKRFT	5" x 5" x 3"	100
#Z113BKRFT	6" x 6" x 4"	100
#Z114BKRFT	6" x 6" x 6"	100
#Z115BKRFT	6" x 4 1/2" x 4 1/2"	100
#Z119BKRFT	9" x 4 1/2" x 4 1/2"	100
#Z120BKRFT	8" x 8" x 4"	100
#Z131BKRFT	12" x 6" x 6"	50
#Z180BKRFT	3" x 3" x 3"	100
#Z181BKRFT	4" x 4" x 2"	100

# Jewelry Boxes



## Cotton Filled Jewelry Boxes

### Gold Linen Foil

Item #	Size	Packed
#ZG40	2 5/8" x 1 1/2" x 1"	100
#ZG50	3 1/4" x 2 1/4" x 1"	100
#ZG60	3 1/2" x 3 1/2" x 1"	100
#ZG65	3 1/2" x 3 1/2" x 2"	100
#ZG80	8" x 2" x 1"	100
#ZG85	8 1/8" x 5 5/8" x 1 3/8"	100
#ZG90	5 3/8" x 3 7/8" x 1"	100
#ZG95	7 1/8" x 5 1/8" x 1 1/8"	100

### Silver Linen Foil

Item #	Size	Packed
#ZS40	2 5/8" x 1 1/2" x 1"	100
#ZS50	3 1/4" x 2 1/4" x 1"	100
#ZS60	3 1/2" x 3 1/2" x 1"	100
#ZS65	3 1/2" x 3 1/2" x 2"	100
#ZS80	8" x 2" x 1"	100
#ZS85	8 1/8" x 5 5/8" x 1 3/8"	100
#ZS90	5 3/8" x 3 7/8" x 1"	100
#ZS95	7 1/8" x 5 1/8" x 1 1/8"	100

### Black Gloss

Item #	Size	Packed
#ZBK40	2 5/8" x 1 1/2" x 1"	100
#ZBK50	3 1/4" x 2 1/4" x 1"	100
#ZBK60	3 1/2" x 3 1/2" x 1"	100
#ZBK65	3 1/2" x 3 1/2" x 2"	100
#ZBK80	8" x 2" x 1"	100
#ZBK85	8 1/8" x 5 5/8" x 1 3/8"	100
#ZBK90	5 3/8" x 3 7/8" x 1"	100
#ZBK95	7 1/8" x 5 1/8" x 1 1/8"	100

### White Krome

Item #	Size	Packed
#ZW40	2 5/8" x 1 1/2" x 1"	100
#ZW50	3 1/4" x 2 1/4" x 1"	100
#ZW60	3 1/2" x 3 1/2" x 1"	100
#ZW65	3 1/2" x 3 1/2" x 2"	100
#ZW80	8" x 2" x 1"	100
#ZW85	8 1/8" x 5 5/8" x 1 3/8"	100
#ZW90	5 3/8" x 3 7/8" x 1"	100
#ZW95	7 1/8" x 5 1/8" x 1 1/8"	100

### Brown Kraft

Item #	Size	Packed
#ZKFT40	2 5/8" x 1 1/2" x 1"	100
#ZKFT50	3 1/4" x 2 1/4" x 1"	100
#ZKFT60	3 1/2" x 3 1/2" x 1"	100
#ZKFT65	3 1/2" x 3 1/2" x 2"	100
#ZKFT80	8" x 2" x 1"	100
#ZKFT85	8 1/8" x 5 5/8" x 1 3/8"	100
#ZKFT90	5 3/8" x 3 7/8" x 1"	100
#ZKFT95	7 1/8" x 5 1/8" x 1 1/8"	100

### Leopard Print

Item #	Size	Packed
#ZLE040	2 5/8" x 1 1/2" x 1"	100
#ZLE050	3 1/4" x 2 1/4" x 1"	100
#ZLE060	3 1/2" x 3 1/2" x 1"	100
#ZLE065	3 1/2" x 3 1/2" x 2"	100
#ZLE080	8" x 2" x 1"	100
#ZLE085	8 1/8" x 5 5/8" x 1 3/8"	100
#ZLE090	8 1/8" x 5 5/8" x 1 3/8"	100
#ZLE095	7 1/8" x 5 1/8" x 1 1/8"	100

### Zebra Print

Item #	Size	Packed
#ZZEB40	2 5/8" x 1 1/2" x 1"	100
#ZZEB50	3 1/4" x 2 1/4" x 1"	100
#ZZEB60	3 1/2" x 3 1/2" x 1"	100
#ZZEB65	3 1/2" x 3 1/2" x 2"	100
#ZZEB80	8" x 2" x 1"	100
#ZZEB85	8 1/8" x 5 5/8" x 1 3/8"	100
#ZZEB90	8 1/8" x 5 5/8" x 1 3/8"	100
#ZZEB95	7 1/8" x 5 1/8" x 1 1/8"	100

# Stock Tissue Papers

## White & Kraft

Item #	Color	Size	Sheets per Pack
#ZTISS1	White	15" x 20"	960
#ZTISS2	White	20" x 30"	960
#ZTISS2KFT	Kraft	20" x 30"	960

## Colors

Item #	Color	Size	Sheets per Pack
#ZTNE100	Light Pink	20" x 30"	480
#ZTNE130	Red	20" x 30"	480
#ZTNE145	Fuchsia	20" x 30"	480
#ZTNE160	Purple	20" x 30"	480
#ZTNE170	Dubonnet	20" x 30"	480
#ZTNE190	Peach	20" x 30"	480
#ZTNE200	Orange	20" x 30"	480
#ZTNE220	Yellow	20" x 30"	480
#ZTNE235	Pistachio	20" x 30"	480
#ZTNE270	Dark Green	20" x 30"	480
#ZTNE277	Tapestry Green	20" x 30"	480
#ZTNE280	Light Blue	20" x 30"	480
#ZTNE300	Turquoise	20" x 30"	480
#ZTNE325	Lilac	20" x 30"	480
#ZTNE340	Plum	20" x 30"	480
#ZTNE345	Cranberry	20" x 30"	480
#ZTNE350	French Vanilla	20" x 30"	480
#ZTNE360	Desert Tan	20" x 30"	480
#ZTNE362	Terracotta	20" x 30"	480
#ZTNE370	Chocolate	20" x 30"	480
#ZTNE385	Navy Blue	20" x 30"	480
#ZTNE390	Gray	20" x 30"	480
#ZTNE400	Black	20" x 30"	480

## Prints

240 Sheets per pack. 20" x 30".

Item #	Color	Size	Sheets per Pack
#ZTRC720	Leopard Skin	20" x 30"	240
#ZTRC730	Zebra Skin	20" x 30"	240
#ZTRC740	Tiger Skin	20" x 30"	240
#ZTRC760A	Blue Bandanna	20" x 30"	240
#ZTRC760B	Red Bandanna	20" x 30"	240
#ZTRC850A	Black Cow	20" x 30"	240
#ZTRC910A	Red Little Hearts	20" x 30"	240
#ZTRC960	Camouflage	20" x 30"	240
#ZTRC1078	Peacock	20" x 30"	240

## Metallics

Item #	Color	Size	Sheets per Pack
#ZTRC90	Gold	20" x 30"	200
#ZTRC109	Silver	20" x 30"	200
#ZTRC119	Bronze	20" x 30"	200

## Assorted Packs

20" x 30".

Item #	Description
#ZPRISIM	36 assorted colors, 24 sheets/color. 864 sheets/pack.
#ZSPRING-F	6 pastel colors, 96 sheets/color. 576 sheets/pack.

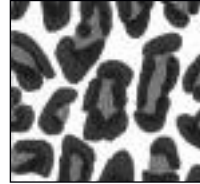

#ZTRC720  
Leopard Skin



#ZTRC730  
Zebra Skin

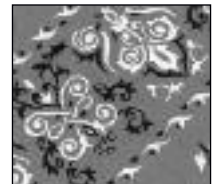

#ZTRC760B  
Red Bandanna



#ZTRC850A  
Black Cow

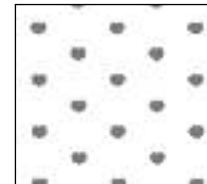

#ZTRC910A  
Red Little Hearts



#ZTRC1078  
Peacock

**NEW**

## Low Cost Tissue



Item #	Color	Size	Sheets per Pack
#ZTIS/W1	White	15" x 20"	480
#ZTIS/W2	White	20" x 30"	480
#ZTIS/K2	Kraft	20" x 30"	480
#ZTIS/001	Red	20" x 30"	480
#ZTIS/004	Hot Pink	20" x 30"	480
#ZTIS/006	Light Pink	20" x 30"	480
#ZTIS/018	Black	20" x 30"	480
#ZTIS/022	Torquoise	20" x 30"	480
#ZTIS/027	Purple	20" x 30"	480
#ZTIS/028	Light Blue	20" x 30"	480
#ZTIS/029	Orange	20" x 30"	480
#ZTIS/030	Lilac	20" x 30"	480
#ZTIS/031	Dark Green	20" x 30"	480
#ZTIS/032	Yellow	20" x 30"	480
#ZTIS/331U	Pistachio	20" x 30"	480
#ZTIS/7401U	French Vanilla	20" x 30"	480

See Inside Back Cover for Color Samples

# Ribbons & Bows



## Natural Raffia

2 oz & 8 oz Bags

Item#	Description	Packed
#ZRAF130/2	red	2oz bag
#ZRAF640/2	royal blue	2oz bag
#ZRAF810/2	natural	8oz bag



## Matte Wraphia

100 yard rolls

Item#	Description	Packed
#ZRWRAP02	pink	roll
#ZRWRAP09	purple	roll
#ZRWRAP13	red raspberry	roll
#ZRWRAP87	kraft	roll



## Flora Satin Pull Bows

4" x 7/8" x 18 loops

Item#	Description	Packed
#ZB301	white	50

5 1/2" x 1 7/16" x 20 loops

Item#	Description	Packed
#ZB401	white	50



## Pre-tied Elastic Bows

Item#	Description	Packed
#ZE18G	Gold 18" Diameter	50
#ZE18S	Silver 18" Diameter	50



## Crimped Splendorette Curling Ribbon

3/16" x 500 yard rolls

Item#	Description	Packed
#ZC101	white	roll
#ZC102	pink	roll
#ZC105	yellow	roll
#ZC163	imperial red	roll

# Message Signs



#XP01  
19" x 15"  
Front and Back



#XP02  
12" X 9"



#XCL  
6 7/8" x 5 5/8"  
Front and Back



#XSP74  
9" x 12"



#XP05  
12" X 9"



#XBH  
12" X 9"

## Message Signs

Signs are 4" x 9", with a dark red ink on a sturdy white vinyl sheet.

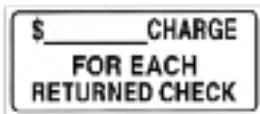

#XM1



#XM2



#XM3



#XM4



#XM5



#XM6



#XM7



#XM9



#XM10



# Promotional & Message Signs

## Sign Cards

Available in 5½" x 7" or 7" x 11". 100 per pack .



Yellow card w/Red letters.  
**#X/57-1** 5½" X 7"  
**#X/711-1** 7" X 11"



Neon Orange card w/Black letters.  
**#X/57-2** 5½" X 7"  
**#X/711-2** 7" X 11"



Yellow card w/Red letters.  
**#X/57-3** 5½" X 7"  
**#X/711-3** 7" X 11"

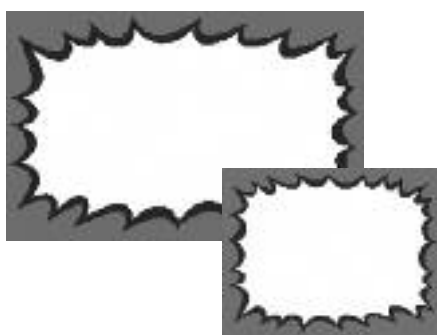

Neon Orange card w/Blue trimmed burst.  
**#X/57-4** 5½" X 7"  
**#X/711-4** 7" X 11"

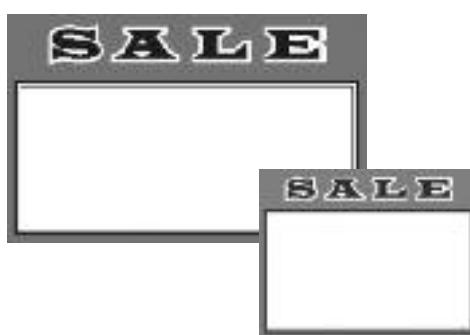

Neon Orange card w/Blue letters.  
**#X/57-8** 5½" X 7"  
**#X/711-8** 7" X 11"



Neon Orange card w/Blue letters.  
**#X/57-9** 5½" X 7"  
**#X/711-9** 7" X 11"

## Printable Sign Cards

Available in 5½" x 7" or 7" x 11" on 8½" x 11" perforated sheets. 100 sheets per pack.



Blue card w/Red & Yellow letters.  
**#X/57-5** 5½" X 7" (2 per sheet)  
**#X/711-5** 7" X 11"



Black & Green card w/Green letters.  
**#X/57-6** 5½" X 7" (2 per sheet)  
**#X/711-6** 7" X 11"



Red card w/Yellow letters.  
**#X/57-7** 5½" X 7" (2 per sheet)  
**#X/711-7** 7" X 11"

# Promotional Signs

## Bulletin Signs

22" x 28" Poster Bulletin Sign w/backer board. 2 per pack.



Blue Bulletin Sign  
w/Red & Yellow letters.  
#X/BS2228-1



Black & Green Bulletin Sign  
w/Green letters.  
#X/BS2228-2



Yellow Bulletin Sign  
w/Red letters.  
#X/BS2228-3



Red Bulletin Sign  
w/Yellow letters.  
#X/BS2228-4

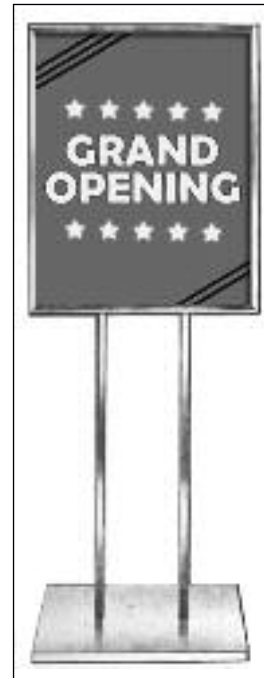

See page 41 for  
Bulletin Sign Holders.

## Ceiling Arrows

19" x 25" Poster Arrows.  
(includes ceiling hooks)  
5 per pack .



Black & Green Arrow  
w/Green letters.  
#X/A1925-1



Yellow Arrow  
w/Red letters.  
#X/A1925-2

## Pennants

13½" x 19½" Poster Pennant. 12 per pack.



Blue Pennant  
w/Red & Yellow letters.  
#X/P1319-1



Black & Green Pennant  
w/Green letters.  
#X/P1319-2



Yellow Pennant  
w/Red letters.  
#X/P1319-3



Red Pennant  
w/Yellow letters.  
#X/P1319-4

# Clamps & Signholders



## Heavy Weight Bulletin Signholder

Chrome  
22"W x 28"H  
#RBH29

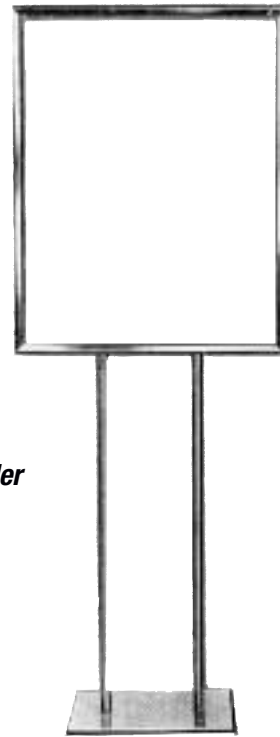

## Economy Weight Bulletin Signholder

Chrome  
14"W x 22"H  
#RBSH1  
Chrome  
22"W x 28"H  
#RBSH2



## Single Signholder

Rectangular Tubing  
22"W x 28"H  
Chrome  
#RBH30  
Matte Black  
#RBH30BK



## Adjustable Aluminum Easel

64" Max Hieght.  
#M333 \$58.75

#CNS3 3" Swedged Stem  
#CM3 3" Threaded Stem  
#CM6 6" Threaded Stem



**Clamp**  
Fits 1 1/16" round tubing  
#MOC1  
Fits 1 5/16" round tubing  
#MOC2



**Clamp**  
Fits 1 1/16" round tubing  
#MCLM1  
Fits 1 5/16" round tubing  
#MCLM2



**Clamp**  
Fits 3/4" vertical square tubing  
#MSC7



**Clamp**  
Fits 1/2" x 1 1/2" rectangular tubing  
#MSC6



**Clamp**  
Fits 1" square tubing  
#MSC5



**Clamp**  
All purpose clamp to fit round, square and rectangular tubing.  
#MSC22



**Magnetized Clamp**  
with threaded fitting  
#MSC20



**Spring Clamp**  
Fits 1" square tubing  
#MSC8



**Spring Clamp**  
Fits 1/2" x 1 1/2" rectangular tubing  
#MSC11



**Magnetized Base**  
with threaded fitting  
#MSC17

# Signholders & Cardframes



**Lucite Counter Cardframe**

#CPK57 5½" H x 7" W  
#CPK711 7" H x 11" W



**Counter Cardframe**

#CMCP57 5½" H x 7" W  
#CMCP711 7" H x 11" W  
#CMCP114 11" H x 14" W



**Sign Holders**

5½" x 7" Double Sided  
#RM/MC57CT



#RM/MC57  
5½" x 7"  
Card Frame w/stem



**Mitered Corner Cardframe**

#MC57 5½" H x 7" W  
#MC711 7" H x 11" W



**Round Corner Cardframe**

#MCF1 5½" H x 7" W  
#MCF2 7" H x 11" W



**Plastic Ticket Holder**  
#M6738 1¼" x 1"



**Bottom Loading Lucite Cardholder**

#CPG57 5½" H x 7" W  
#CPG711 7" H x 11" W  
#CPG811 11" H x 8½" W  
#CPG118 8½" H x 11" W



**Lucite Cardframe**

#CPJ57 5½" H x 7" W  
#CPJ711 7" H x 11" W  
#CPJ811 11" H x 8½" W  
#CPJ118 8½" H x 11" W



**Alligator Clip Sign Holder**

Satin Nickel, Down Position  
with 6" square base.

Item#	Height
#CAC1	12"
#CAC2	24"
#CAC4	42"



**Lucite Slant Back Cardholder**

#CPH57 5½" H x 7" W  
#CPH711 7" H x 11" W

Lucite items require special packaging. A \$5.00 fee per shipping carton will be automatically added to your order.

# Mirrors



**Three Way Mirror**  
Center Mirror 31" W x 60" H  
Side Mirrors 24" W x 60" H  
Overall Height 84"  
(some assembly required)  
#RM/TWM101



**3 Way Mirror**  
Center panel 22" W x 60" H  
Side panels 20" W x 60" H  
Overall height 68"  
with chrome stand  
#CM3W5



**Adjustable Tilt Single Mirror**  
20"W x 60"H with  
1" square tubing frame  
4 casters.  
#TSM

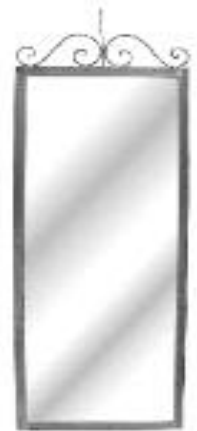

**Hanging Wall Mirror**  
with wall mounts.  
24" W x 60" H  
#RM/HWM101



**Oval Floor Mirror**  
Single sided.  
28" W x 58" H  
#RM/FM100



**Shoe Mirror**  
Double sided.  
16" W x 18" H  
#RM/SM101



**Counter Mirror**  
Single sided.  
5" W x 15 1/2" H  
#RM/CM200



**Counter Mirror**  
Single sided.  
16" W x 24" H  
#RM/CM100



**Tilting Mirror**  
Lucite frame, single sided.  
10"W x 20"H  
#C485



**Counter Mirror**  
Lucite frame, single sided.  
6"W x 14"H  
#C1801



**Counter Mirror**  
Metal frame, double sided.  
10"W x 16"H 6"Round Base  
#C1014R6



**All Lucite Counter Mirrors**  
#CJ912 9" W x 12" H  
#CJ1114 11" W x 14" H  
#CJ1219 12" W x 19" H

Lucite items require special packaging. A \$5.00 fee per shipping carton will be automatically added to your order.

# Lucite Literature Holders & Counter Displays



**Deep Locking Case**  
11" x 20" x 4.5"  
#C2101



**Security Case with Sliding Back Door**  
21"W x 7"D x 13"H  
Lock included  
#C1467



**Locking Security Case**  
24"W x 3"H x 18"D  
#CASE1



**Triple Lucite Counter Hosiery Display**  
16.25"W x 12"D x 10.5"H  
#C1347



**Four Tier Literature/Video Display**  
16.25"W x 11.5"D x 11.5"H  
#C1216

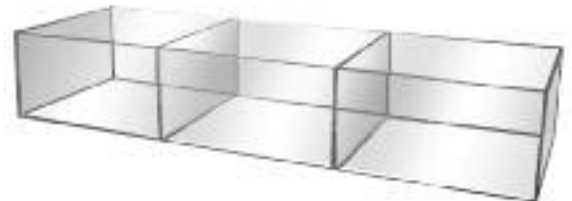

**Counter Hosiery Tray**  
24"W x 4"H x 8"D  
#CTRAY

## Counter Top Literature Holders

Single Pocket, 1.5" Deep.

- #C1081 4"W x 9"H
- #C1085 8.5"W x 11"H

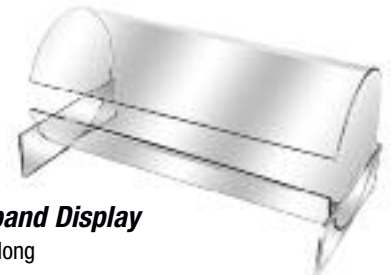

**Headband Display**  
11.75" long  
#C1098

## Shoe Displays



**Single Lucite Shoe Display**  
#CJ1



**Up & Down Single Shoe Display**  
#C477



**Single Lucite Shoe Display**  
#C1039



**Double Lucite Shoe Display**  
#C1156



**Acrylic Shoe Insert**  
#C398

# Lucite Risers & Easels

## Lucite Risers

### 3 Cube Riser Set

3", 4" & 5" Cubes

#C379



### 3 Riser Set

4"H x 6"W x 6"D

6"H x 8"W x 6"D

8"H x 10"W x 6"D

#C381



### Individual Riser Cubes

#C3806 6" Cube

#C3808 8" Cube

#C38010 10" Cube

#C38012 12" Cube

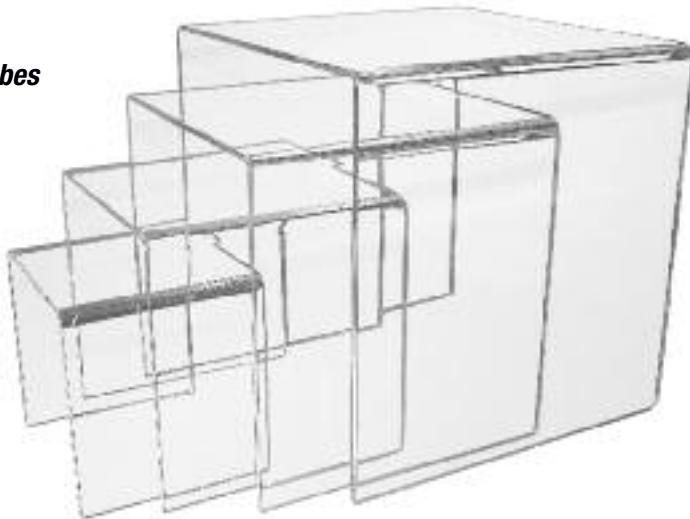

### 6 Riser Set

Ranging in size from:

3"H x 6"W x 4"D to

6"H x 8"W x 4"D

#C382



## Easels

### Adjustable Plastic Easels



#CMINI

Clear Plastic  
2" x 3¼" x 2¼"



#C2PL

White Vinyl  
& Clear Plastic  
5½" x 4"

### Adjustable Wire Easels



#C1A

White Vinyl  
4¼" x 3"



#C2AX

White Vinyl  
4¼" x 4¼"



#CDCW

White Vinyl  
9¼" x 5¼"

### Lucite Easels



#C1078

Shirt Easel  
7"W x 12"H



#C38

Bag Easel  
7½"H x 3"W



#C39

Bag Easel  
5½"H x 3"W



#C682

Bag Easel  
5"H x 3½"W



#C683

Five Way  
Clutch Bag Display

Lucite items require special packaging. A \$5.00 fee per shipping carton will be automatically added to your order.

# Lucite Earring & Eyewear Displays

## Eyewear Displays

#C1484



#C1480



#C751



### Eyewear Posts

- #C1491 1 Pair. 3 1/4" High
- #C1492 2 Pair. 6 1/4" High
- #C1493 3 Pair. 9 1/4" High



#C1491



#C1492



#C1493

### Revolving & Stationary Eyewear Displays

- #C1484 24 Pair Revolving Display. White and Clear Lucite. 18" High
- #C1480 6 Pair Stationary Display. Clear Lucite. 14.5" High
- #C751 6 Pair Stationary Display. Clear Lucite. 17.75" High

## Revolving Earring Displays



#AER/25  
with lock  
8" W X 8" D X 18.5" H



#AER/15  
10" W X 10" D X 24.5" H



#AER/10  
10" W X 10" D X 17" H



#AER/5  
5" W X 5" D X 17" H



**Lucite Earring Display**  
4.75" high  
#C6110



**Counter Earring Display**  
11.25" x 19"  
#CJEAR



**Grey Earring Card**  
#AEC/572 Blank



**Black Earring Card**  
#AEC/573 Blank



**White Earring Card**  
#AEC/579 Blank



# Aaron Contemporary™ Raw Steel Fixtures

## Jewelry Displays



**Jewelry Display**

3 Tier  
15" High  
#RM/JDB20



**Earring Card Display**

10"W x 6"D x 15"H  
#RM/JDE1



**Spinner Earring Card Display**

10"W x 6"D x 15"H  
#RM/JDE2



**Two Tier Watch Display**

9 1/4"H x 10 1/4"W  
#RM/JDW101



**24 Pair Earring Display**

15" High  
#RM/JDE116



**Jewelry & Keychain Display**

16" High  
#RM/JDM3



**Necklace Display**

Adjusts from 13"-21"H  
11"W x 6"D  
#RM/JDN101



**Earring Display**

T-Type  
5 1/2" High  
#RM/JDE74



**6 Pair Earring Display**

7" High  
#RM/JDE6



**Sign Holders**

5 1/2" x 7" Double Sided  
#RM/MC57CT



**Set of 3 Cubes**

4"H x 6"W x 6"L  
6"H x 6"W x 8"L  
8"H x 6"W x 10"L  
#RM/CS381

**2 Tier Jewelry Display**

12" High  
#RM/JD2T



**Jewelry Stand**

15" High  
#RM/JD115ARD



**Jewelry Displayer**

10" High  
#RM/JD110



**Jewelry Displayer**

16" High  
#RM/JD116



# White Leatherette Jewelry Displays

## Necklace & Bracelet Displays

**Large Bust**  
6 1/2" x 8"  
#AL1801LW



**Large Bust**  
7 1/4" x 8 3/4"  
#AL1711LW



**Necklace Display**  
8" x 11"  
#AL1892LW



**Necklace Stand**  
9" x 14 1/2"  
#AL181LW



**Ramp**  
1 1/2" x 8" x 2"  
#AL239LW



**Ramp**  
4 1/2" x 8" x 2"  
#AL2392LW



**Necklace Pad w/ Easel**  
4" x 8 1/2"  
#AL67KLW



**Necklace Pad w/ Easel**  
8" x 11"  
#AL602LW



**Hook Easel Stand**  
7 1/2" x 14"  
#AL68HLW



**Dome**  
8 1/4" x 5" x 2 1/4"  
#AL230LW



**Display Pillow**  
3" x 3"  
#AL113LW



**Display Pillow**  
4" x 4"  
#AL112LW



**12 Bracelet Tray**  
7 1/2" x 10"  
#AF824



**Oval T Bar Display**  
4 1/2" x 8"  
#AL2192ALW



**Double T Bar Display**  
8" x 6"  
#AL2182ALW



**T Bar Display**  
12" H  
#AL2191BLW



**3 Bar Round Display**  
12" x 13"  
#AL216LW

## Pads & Riser Displays

**Oval Display Pad**  
7" x 11"  
#AL3511LW



**Oval Display Pad**  
4" x 7"  
#AL3513LW

**6 pc. Hexagonal Display**  
#AL513L1W

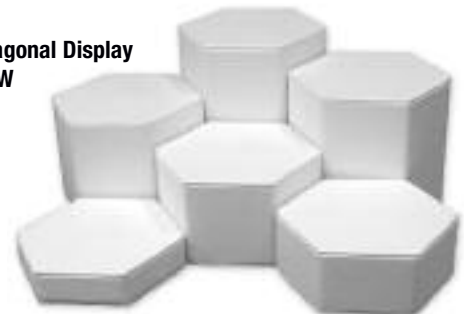

# White Leatherette Jewelry Displays

## Earring Displays



Earring Display  
3 1/4"  
#AL225LW



6 Pair  
Earring Display  
#AL223LW



Earring Display  
4 1/2"  
#AL246LW



Earring Display  
4 3/4"  
#AL2412LW



Earring Display  
4 1/2"  
#AL2403LW



Earring Display  
5 1/2"  
#AL2402LW



7" Leaf  
Earring Display  
#AL248LW

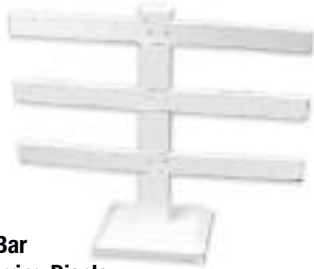

3 Bar  
Earring Display  
10 1/4" x 8 1/2"  
#AL2523LW



46 pc. Ring Tray  
7 1/2" x 10"  
#AF821



24 pc.  
Earring / Pendant Tray  
7 1/2" x 10"  
#AF822



16 pc.  
Earring / Pendant Tray  
7 1/2" x 10"  
#AF823

## Ring Displays & Insert



5 Ring Display  
#AL2455LW



Single Finger Display  
#AL2444LW



3 Ring Cluster  
#ARD203LW



Display Pad  
12" x 24"  
#AL931LW

## Polystyrene Hand Displays



14" High  
#A236

8" High  
#A235

2 1/2" High  
#A234

### *Adjustable Acrylic Watch Stands*

Set of 3  
#A1497



#A/FR22N  
22 5/16" Mini Display Form  
with 2 Neckblocks  
in Natural



#A/FR22B  
22 5/16" Mini Display Form  
with 2 Neckblocks  
in Black

# Beige Linen Jewelry Displays

## Earring & Necklace Displays



**Earring Stand**  
2" x 1½" x 3"  
#ALIN/ER5



**Curved Earring Stand**  
1¼" x 2¼"  
#ALIN/ER10



**Necklace Pad w/ Easel**  
3¾" x 5½"  
#ALIN/NE30



**Necklace Pad w/ Easel**  
4¼" x 8⅞"  
#ALIN/NE32



**Necklace Pad w/ Easel**  
8¼" x 9"  
#ALIN/NE34



**Necklace Pad w/ Easel**  
8⅞" x 14⅛"  
#ALIN/NE36



**Counter Pad**  
14.125" x 7.625"  
#ALIN/PD5



**18 Pc. Ring Tray**  
2" x 1.5" x 3"  
#ALIN/R18



**Necklace Display**  
8¼" x 14½"  
#ALIN/NS53



**Necklace Display**  
9½" x 18"  
#ALIN/NS55

## Necklace Displays



**Necklace Display**  
6¾" x 8" x 4"  
#ALIN/ND10



**Necklace Display**  
6¾" x 7½" x 3½"  
#ALIN/ND13



**Necklace Display**  
6½" x 8¼"  
#ALIN/NS50

## Watch & Bracelet Displays



**Single Round T-Bar**  
12" x 7"  
#ALIN/TB12



**Single Round T-Bar**  
7½" x 4⅞"  
#ALIN/TB10



**Double Oval T-Bar**  
7½" x 7"  
#ALIN/TB20

## Necklace & Bracelet Displays



**Single Round T-Bar**  
12" x 12"  
#ALIN/TB14



**Single Round T-Bar**  
12" x 18⅞"  
#ALIN/TB17



**Double Round T-Bar**  
9⅞" x 10⅞"  
#ALIN/TB25



**Tripe Round T-Bar**  
12" x 12¾"  
#ALIN/TB30

# Jewelry Displays

## Jewelry Leatherette Displays



#ASET65GF 23 Pc. Steel Grey Faux



#ASET65BK 23 Pc. Black Faux



#ASET63LW 18 Pc. White Leatherette



#ASET65LW 23 Pc. White Leatherette



#ASET62LW 24 Pc. White Leatherette

## Jewelry Bags

### Sheer Bags

Item #	Size	Pack/Qty
#AJB/R10	3" x 4"	10
#AJB/R15	4" x 5 1/2"	10
#AJB/R20	5" x 6 1/2"	10
#AJB/R25	5 1/2" x 9"	10

Colors Available: Black, Light Blue, Light Green, Lavender, Pink, Yellow, White, Red, Purple, Olive, Burgundy, Mauve, Navy, Gold, Smoke Blue, Orange, Silver.



Sheer Bags

### Velveteen Bags

Item #	Size	Pack/Qty
#AJB/V50	2" x 2 1/2"	10
#AJB/V60	3" x 3"	10
#AJB/V70	3" x 4"	10
#AJB/V80	4" x 5"	10

Colors Available: Black, Burgundy, Silver, Hunter Green, Navy Blue, Red, Royal Blue



Velveteen Bags

### Jute Bags

Item #	Size	Pack/Qty
#AJB/J10	3" x 5 1/2"	10
#AJB/J20	5" x 6"	10

Colors Available: Natural



Jute Bags



### Cotton Muslin Bags



### Cotton Muslin Bags

Item #	Size	Pk/Qty
#AJB/C10	3" x 4"	10
#AJB/C15	4" x 6"	10
#AJB/C25	5" x 8"	10
#AJB/C30	6" x 10"	10
#AJB/C35	8" x 12"	10
#AJB/C40	10" x 16"	10

Colors Available: Natural Cotton Muslin



### Metallic Bags



### Metallic Bags

Item #	Size	Pk/Qty
#AJB/LAME10	3" x 4"	10
#AJB/LAME20	5" x 7"	10
#AJB/LAME25	6" x 10"	10
#AJB/LAME30	6" x 14"	10

Colors Available: Silver and Gold



# Black Velvet Jewelry Displays

## Earring Displays



1 Pair  
Earring Display  
3 1/4"  
#A33123B



5 Pair  
Earring Display  
3 1/4"  
#A33125B



Earring Display  
4"  
#A246



Earring Display  
5 1/4"  
#AER1B



Earring Display  
5 1/2"  
#AED3B



Earring Display  
5"  
#A33114B



7" Leaf  
Earring Display  
#A248

## Ring Displays



Single Finger Ring  
Display  
#A32984B



5 Ring Display  
#A32986B

3 Bar  
Earring Display  
10" x 9"  
#A33118B



10 Pair  
Earring Display  
12" x 7"  
#A33119B

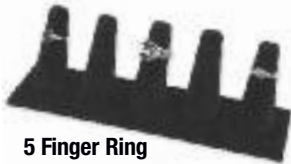

5 Finger Ring  
Display  
#A32988B



4 Ring Display  
#A32993B



Pillow Display  
3" x 3"  
#A113SB



Pillow Display  
4" x 4"  
#A112SB



Display Dome  
8 1/4" x 5" x 2 1/2"  
#A33155B

## Watch & Bracelet Displays



Small Ramp  
1 1/2" x 8" x 2 1/2"  
#A33156B



Ramp  
4 1/2" x 8" x 2"  
#A33153B



Watch Display  
#ASKPEX3



Oval T-Bar  
7 1/2" x 7"  
#A33159B



Double  
Oval T-Bar  
7 1/2" x 7"  
#A33160B



**L-Shaped Jewelry Display**  
Chrome Adjustable  
14"-15"  
#CJS/1L



**T-Shaped Jewelry Display**  
Chrome Adjustable  
12" W 14"-15"  
#CJS/1T

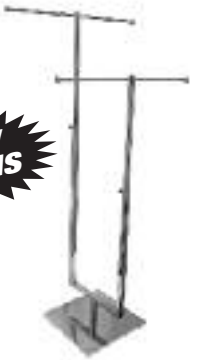

**NEW ITEMS**

**2 Tier Jewelry Display**  
Chrome Adjustable  
12" W 18"-29"  
#CJS/2



**3 Tier Jewelry Display**  
Chrome Adjustable  
12" W 18"- 29"  
#CJS/3



**40 Hook Jewelry Stand**  
Chrome Adjustable  
15" x 18"  
#CJS/40H

# Black Velvet Jewelry Displays

## Necklace & Bracelet Displays



**Large Bust**  
6 1/4" x 8"  
#A33102B



**Large Bust**  
7 1/4" x 8 3/4"  
#A33101B



**Necklace Pad  
w/ Easel**  
4 1/8" x 8 1/2"  
#A67KB



**Necklace Stand**  
7" x 11"  
#ANB1B



**Necklace Pad  
w/ Easel**  
8" x 11"  
#A602B



**Necklace Stand**  
9" x 14 1/2"  
#A181BK



**T-Bar Stand**  
11 1/2" x 12"  
#AT12B

**T-Bar Stand**  
11.5" x 18"  
#AT18B



**3 T-Bar Stand**  
12" x 13"  
#A33199B



**7 Hook Stand  
w/ Easel**  
7 1/2" x 14"  
#A68HB



**6 Pc. Hexagonal Set**  
#A33077B

## Jewelry Rolls & Folders

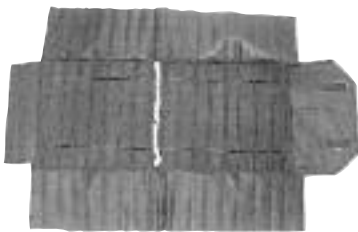

**Economy Bracelet  
& Watch Roll**  
#A33392B

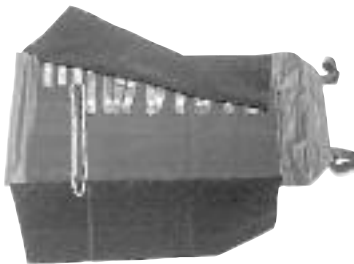

**Economy  
Combination Roll**  
#A33391B



**Economy  
Combination Roll**  
#A33393B

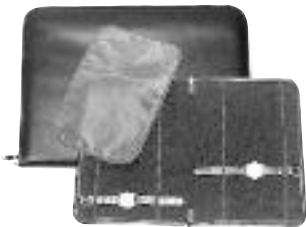

**Zippered  
20 Watch Display**  
#A33190B



**Vinyl Folder**  
#A33444B

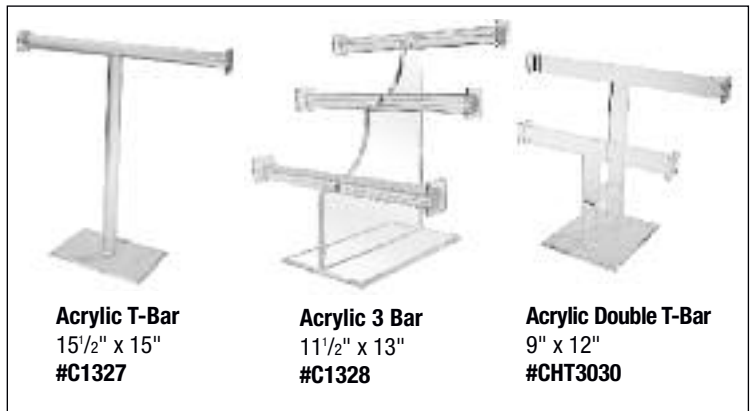

**Acrylic T-Bar**  
15 1/2" x 15"  
#C1327

**Acrylic 3 Bar**  
11 1/2" x 13"  
#C1328

**Acrylic Double T-Bar**  
9" x 12"  
#CHT3030

# Black Jewelry Displays

## Trays & Inserts



#A33255B 1" x 14<sup>3</sup>/<sub>4</sub>" x 8<sup>1</sup>/<sub>4</sub>" Plastic Tray

#A7634 1" x 14<sup>3</sup>/<sub>4</sub>" x 8<sup>1</sup>/<sub>4</sub>" Jewelry Tray

#A7635 1<sup>1</sup>/<sub>2</sub>" x 14<sup>3</sup>/<sub>4</sub>" x 8<sup>1</sup>/<sub>4</sub>" Jewelry Tray

#A7636 2" x 14<sup>3</sup>/<sub>4</sub>" x 8<sup>1</sup>/<sub>4</sub>" Jewelry Tray

#A7637 3" x 14<sup>3</sup>/<sub>4</sub>" x 8<sup>1</sup>/<sub>4</sub>" Jewelry Tray

The inserts shown below can be used in combination with any of the trays shown here.



#A7618B

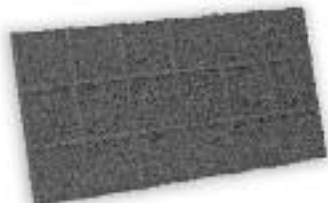

18 Space Insert  
#A18DIV



24 Space Insert  
#A24DIV



72 Ring Foam Insert  
#ARING

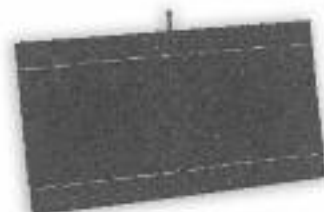

18 Space Insert  
#APP10E



18 Watch Display Tray w/ Inserts  
#A33191B

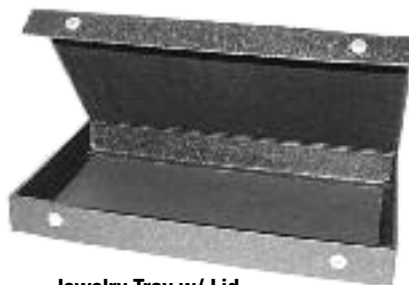

Jewelry Tray w/ Lid  
#AST7635



Jewelry Tray w/ Glass Lid  
#AST7635L

## Velvet Pads



Display Pad  
7" x 11"  
#A33074B

Display Pad  
4" x 9"  
#A33073B

Display Pad  
4" x 7"  
#A33072B



Display Pad  
12" x 24"  
#A93B1

## Jewelry Travel Cases

These carrying cases accommodate the trays shown above.



Soft, Lightweight Jewelry Case  
#ACASE



Aluminum Carrying Case  
#A861-7

## U-Shaped Jewelry Pins

1000 Pack.



#AJP149G Gold  
#AJP149S Silver

## "Dumbbell" Adhesive Jewelry Tags

1000 Pack. Pen included.  
Actual Size 1<sup>3</sup>/<sub>8</sub>"W x 1<sup>1</sup>/<sub>2</sub>"H

#TKB2107 White  
#TKB2107G Gold  
#TKB2107S Silver

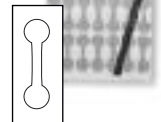



# Assorted Heads & Hosiery Displays

## Display Heads for Wigs and Hats



Display Head  
#FTF/WH1



Display Head  
#FTF/WH2



Display Head  
#FTF/WH3



### Styrofoam Heads

#FGB/HEAD1 10 1/2" Tall  
#FGB/HEAD2 13" Tall



Black Female 13 1/2" Tall  
#FTF/HD40F-BK  
White Female 13 1/2" Tall  
#FTF/HD40F-WHT



Black Female 20" Tall  
#FTF/HD42F-BK  
White Female 20" Tall  
#FTF/HD42F-WHT



Black Male 13 1/2" Tall  
#FTF/HD82M-BK  
White Male 13 1/2" Tall  
#FTF/HD82M-WHT



Black Male 20" Tall  
#FTF/HD86M-BK  
White Male 20" Tall  
#FTF/HD86M-WHT

**NEW ITEMS**



**Plastic Hosiery Leg Display**  
#FTF/PL5F Fleshtone  
#FTF/PL5W White

**NEW ITEMS**

## Hosiery Displays

### Full Round Hosiery Forms With Weighted Toe - Flesh Colored

- #CM32 Men's Sock Form
- #CW40 10 3/4" Ladies Sock Form
- #CW41 15 1/4" Calf High Hosiery Form
- #CW43 18 1/8" Knee High Hosiery Form
- #CW44 26 3/8" Thigh High Hosiery Form
- #CW47 29 3/4" Hip High Hosiery Form

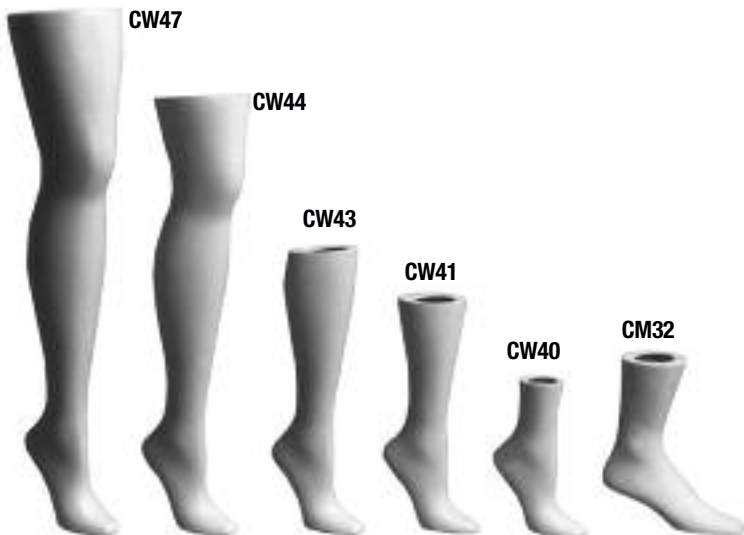

## Polycarbonate Hosiery Displays

- Calf High Display 13" Tall #FPC/LEG1
- Knee High Display 19" Tall #FPC/LEG2
- Full Leg "Toe Up" Display 27 1/2" Tall #FPC/LEG4
- Full Leg "Toe Down" w/base Display 27 1/2" Tall #FPC/LEG5

**NEW ITEMS**



# Low Cost Utility & Display Racks



## Adjustable Double Rack

60" W x 22" D adjust 51" - 72" H

#RSQDA

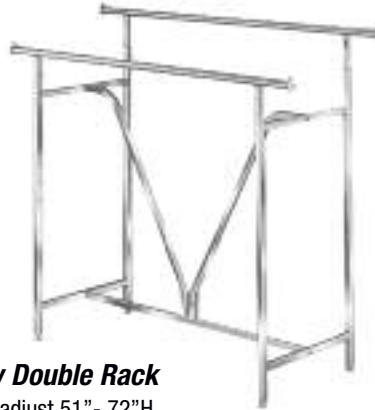

## Extra Heavy Double Rack

60" W x 22" D adjust 51" - 72" H

"V" Construction

#RK41

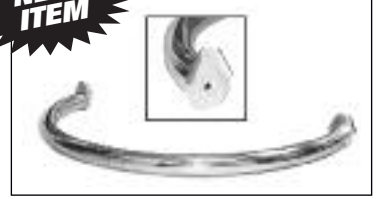

## Half Round Rack Attachment

Round End Hangrail,  
fits #RSQDA & RK41 racks  
Chrome finish

#RSQ-END

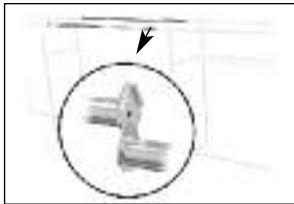

## Double Rack

### Extension Connectors

Use to connect Two #RSQDA together to create 15 Feet of continuous hanging space. Each bar sold separately.

#RAO

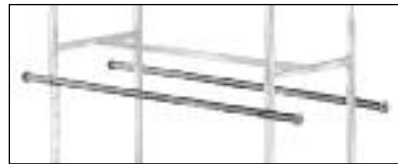

## Double Rack

### Hangrail Attachments

Double the capacity of the #RSDQA. Attaches to frame to allow double hanging. Each bar sold separately.

#RDH

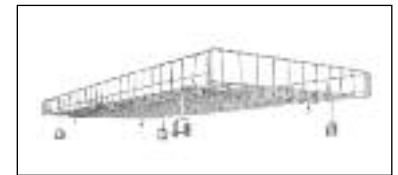

## Double Rack

### Rectangular Rack Topper

23" x 54" Grid Rack Topper has 3" lip on all sides. Chrome finish

#RSQ-TOP

## Round Metal Basket

To fit the 36"-42" Round Rack  
3" D x 30" Dia.

#RVR36-BSK

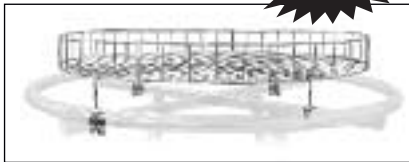

## Round Glass Top

Round tempered glass to fit on top of RVR36, RVR42 & R42R Racks

#LR30 30" Tempered Glass Top

#LR36 36" Tempered Glass Top



## Extra Round Ring

Doubles ring for RVR36 & RVR42.

(must use RHK7 clamps)

#RKH5 36" Diameter



#RKH6 42" Diameter

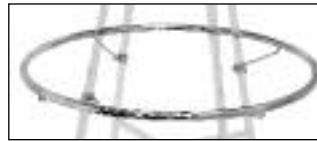

## Set of Four Clamps

Holds the RKH5 & RKH6 round rings.

#RKH7

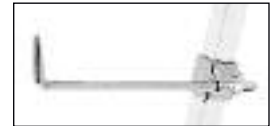

## Chrome Adjustable Round Rack

36" Diameter Adjust 50"-72" H

#RVR36

#LR30 3" Glass Top

42" Diameter Adjust 50"-72" H

#RVR42

#LR36 36" Glass Top



## Adjustable Height Half Round Rack.

Adjusts from 49" to 73".  
42" Diameter arc.

#RHHR

Locking casters can be purchased to be used in place of levelers

## Black Twin Locking Caster

#MCC3LOCK 5/16" x 1" thread

#MCC4LOCK 3/8" x 1" thread



## Top Rests

set of 4 shelf rests, for round wooden or glass top.

#RREST



#RREST supports for glass and wooden top

# Low Cost Square Tubing Racks

## Chrome Four Way Adjustable Costumers



**#RC4**  
Has four 16"  
Straight Arms  
Adjust 52"-73" H  
36" W

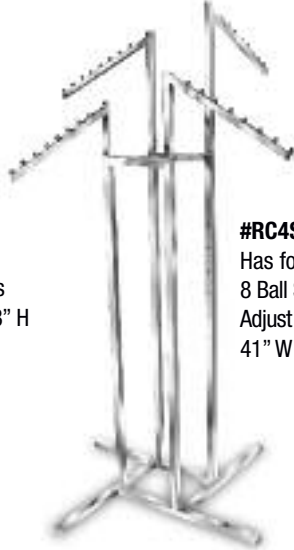

**#RC4S**  
Has four  
8 Ball Slant Arms  
Adjust 52"-73" H  
41" W

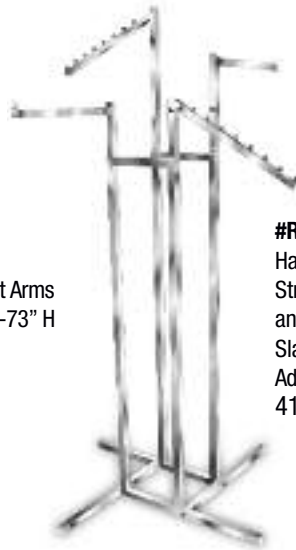

**#RC422**  
Has two 16"  
Straight Arms  
and two 8 Ball  
Slant Arms  
Adjust 52"-73" H  
41" W

## Chrome Two Way Adjustable Costumers



**#RSBC2S**  
With 8 Ball Slant Arms  
Adjust 50"-70" H  
35" W

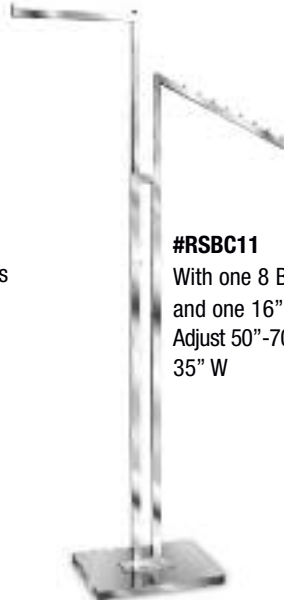

**#RSBC11**  
With one 8 Ball Slant Arm  
and one 16" Straight Arm  
Adjust 50"-70" H  
35" W

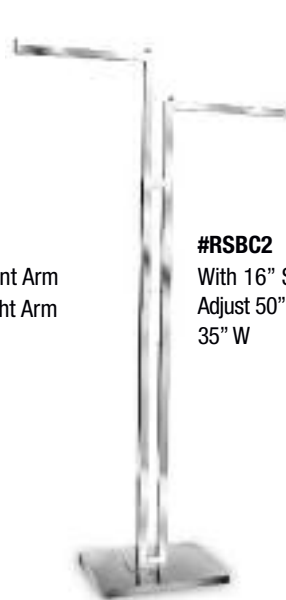

**#RSBC2**  
With 16" Straight Arms  
Adjust 50"-70" H  
35" W

### Arms



**16" Add-On Arm**  
Attaches to Vertical  
Square Tubing.

**#RTV16**



**8 Ball Slant  
Replacement Arm**  
**#RARMSL**



**Straight  
Replacement Arm**  
**#RARMST**

### Black Beauty Racks

Black legs with chrome hangrail.

- #RBB48** 60" W x 48" H
- #RBB54** 60" W x 54" H
- #RBB64** 60" W x 64" H
- #RBB2T\*** 60" W x 76" H

\*Double Hangrail



Locking casters can be purchased  
to be used in place of levelers

### Black Twin Locking Caster

- #MCC3LOCK**  $\frac{5}{16}$ " x 1" thread
- #MCC4LOCK**  $\frac{3}{8}$ " x 1" thread



# Accessory Racks



**"T" Style Shoe Rack**  
 Double Sided Unit 66"H x 48"W  
 8 Shoe Shelves, 12" Deep.  
 Chrome finish.

#RST02 

**Add-On Shoe Shelf**



#RST02/SHELF



**Handbag Rack**

46" W Includes 4 adjustable  
 slant arms 52"-73" and 4  
 twist-on arms. 5 hooks per arm.  
**#RK16**



**Revolving  
 Belt/Tie Rack**  
 20" W x 52" H  
**#RBR6**



**2 Tier Revolving  
 Belt/Tie Rack**  
 27" W x 60" H  
**#RBRD4**



**All Rectangular  
 Tubing Belt Rack**  
 38" W center adjust  
 47"-66"  
**#RBELT**

Locking casters can be purchased  
 to be used in place of levelers

**Black Twin Locking Caster**

#MCC3LOCK  $\frac{5}{16}$ " x 1" thread

#MCC4LOCK  $\frac{3}{8}$ " x 1" thread



**All Rectangular  
 Tubing Belt/Tie Rack**  
 37" W x 57" H  
**#RB56**



Sponge for Hat Displayer  
**#RSPONGE**

**Floor Hat Displayer**  
 16"W x 74" H  
 Holds 20 Hats.  
**#R1822**



**Folding Lingerie Towe.**  
 Has 16 Twist on 12" Arms.  
 35" W x 61" H  
**#RK35**



**29 Ball  
 Spiral Costumer**  
 26" W x 67" H  
 with 18" Base.  
**#R24SC**

# P.O.P. Floor & Counter Displays

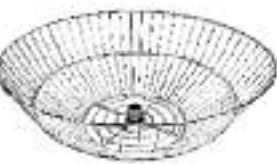

**#RPO/BSK**  
20" Dia. x 10" Dia. x 7" D  
Basket Spinner - Chrome



Sponge for Hat Spinner  
**#RSPONGE**



**#RPO/HAT**  
Hat Spinner - Chrome  
Fits 1" Dia. Upright



**#RPO/6H**  
16" x 13"  
6 Hook Spinner - Chrome  
Fits 1" Upright



**#RPO/BCT**  
12" x 31" High Counter Base  
1" Dia. Chrome upright  
with Black Base

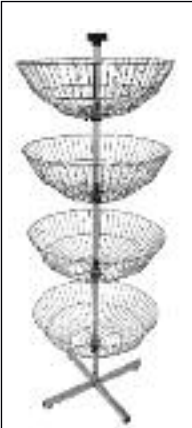

**Assembled Basket Display**

**#RPO/BSK-A**  
(1.) #RPO/B  
(4.) #RPO/BSK

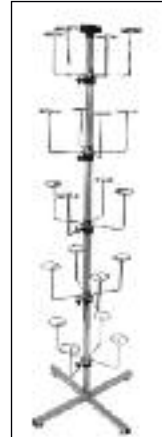

**Assembled Hat Display**

**#RPO/HAT-C**  
(1.) #RPO/B  
(5.) #RPO/HAT



**#RPO/8H**  
18" 8 Hook Spinner - Chrome  
Fits 1" Dia. Upright



**#RPO/10H**  
18" 10 Hook Spinner - Chrome  
Fits 1" Dia. Upright



**#RPO/12H**  
18" 12 Hook Spinner - Chrome  
Fits 1" Dia. Upright

## Counter Bases & Displays

### Adjustable "T" Stands

36" to 72"  
With 5/8" threaded stem.  
**#C7U** Upright  
**#C8B** 8" Base

24" to 48"  
With 5/8" threaded stem.  
**#C6U** Upright  
**#C6B** 6" Base

18" to 36"  
With 5/8" threaded stem.  
**#C5U** Upright  
**#C6B** 6" Base

18" to 36"  
With 3/8" threaded stem.  
**#C4U** Upright  
**#C5B** 5" Base



**Blouse Upright**  
**#C1814**



**Hook Upright**  
**#C1810**



**Chrome Base**  
10" Round Trumpet  
**#CR10**



**Double Purse Display**

Upright and round base.  
Adjusts from 15" to 28" high.  
**#R/DPD10**



**Triple Purse Display**

Upright and round base.  
Adjusts from 16" to 28" high.  
**#R/DPD20**

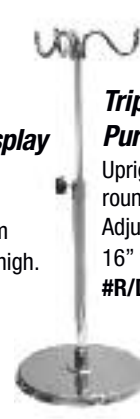

**Extendible Hook Stand**

Upright and lucite base.  
Adjusts from 24" to 42" high.  
**#C4518**

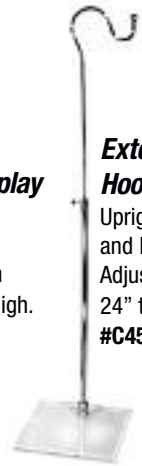

# Raw Steel & Matte Black Racks

## Rectangular Tubing



**Adjustable Single Hangrail**  
Raw Steel Rectangular Rolling Rack  
Adjust 55"-76" H, 48" W x 28" D  
#RSR5475R

Locking casters can be purchased to be used in place of levelers

**Black Twin Locking Caster**

- #MCC3LOCK 5/16" x 1" thread
- #MCC4LOCK 3/8" x 1" thread



**Adjustable Double Hangrail**  
Raw Steel Rectangular Rolling Rack  
Adjust 55"-76" H, 48" W x 28" D  
#RSR5585R



**4 Way Rack**  
Four 8 Cube Slant Arms  
Adjust 50"-71" H, 43" W  
#R4SR Raw Steel  
#RK87MAB Matte Black



**4 Way Rack**  
Two 8 Cube Slant Arms &  
Two 16" Straight Arms  
Adjust 50"-71" H, 43" W  
#R422R Raw Steel  
#RK86MAB Matte Black



**4 Way Rack**  
Four 16" Straight Arms  
Adjust 50"-71" H, 43" W  
#R4R Raw Steel  
#RK85MAB Matte Black

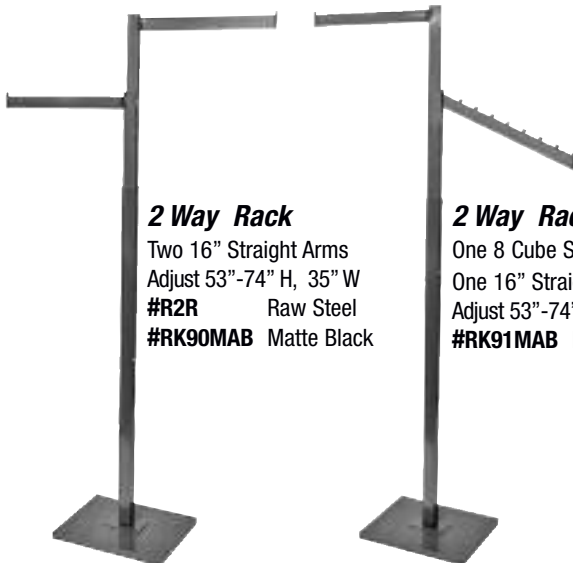

**2 Way Rack**  
Two 16" Straight Arms  
Adjust 53"-74" H, 35" W  
#R2R Raw Steel  
#RK90MAB Matte Black

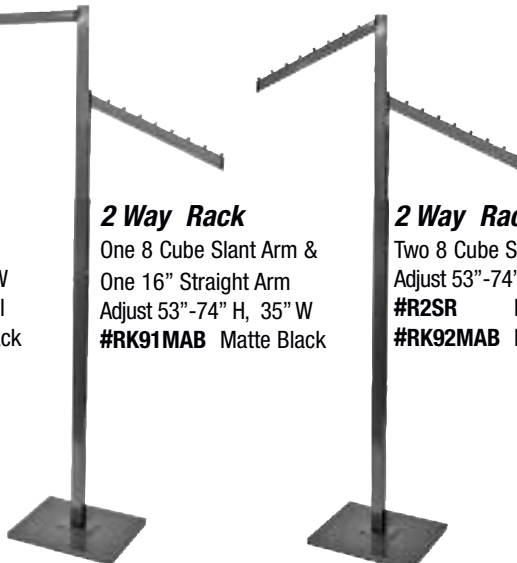

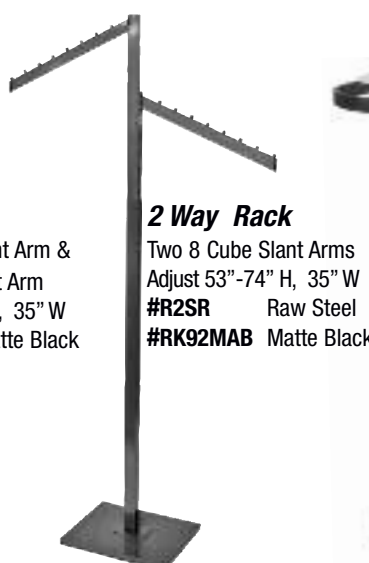

**2 Way Rack**  
One 8 Cube Slant Arm &  
One 16" Straight Arm  
Adjust 53"-74" H, 35" W  
#RK91MAB Matte Black



**2 Way Rack**  
Two 8 Cube Slant Arms  
Adjust 53"-74" H, 35" W  
#R2SR Raw Steel  
#RK92MAB Matte Black



**Adjustable Round Rack**  
42" Diameter  
Adjust 50"-72" H  
#R42R Raw Steel   
#LR36 36" Glass Top 

 Must ship Common Carrier

# Chrome Rectangular Tubing Racks



**Adjustable Single Hangrail**  
 Chrome Rectangular Rolling Rack  
 Adjust 55"-76" H, 48" W x 28" D  
 #RSR5475



**2 Way Rack**  
 Two 8 Cube Slant Arms  
 Adjust 53"-74" H, 33" W  
 #RRBC25

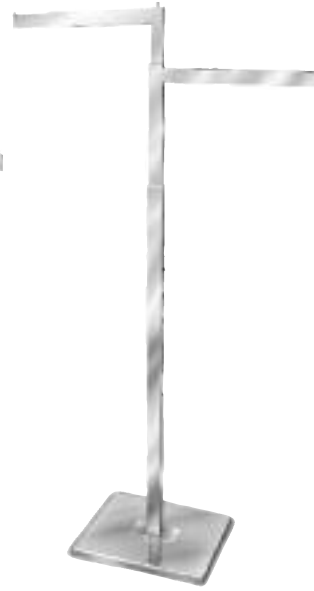

**2 Way Rack**  
 Two 16" Straight Arms  
 Adjust 53"-74" H, 33" W  
 #RRBC2



**2 Way Rack**  
 One 8 cube Slant Arm &  
 One 16" Straight  
 Adjust 53"-74" H, 33" W  
 #RRBC11

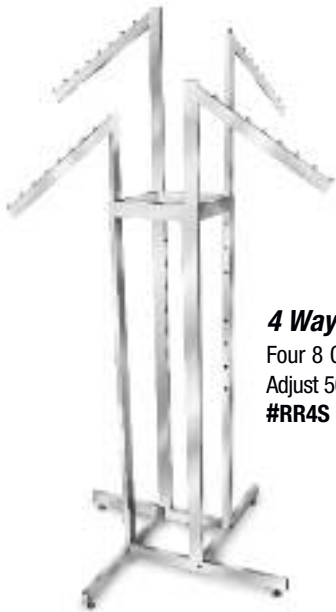

**4 Way Rack**  
 Four 8 Cube Slant Arms  
 Adjust 50"-71" H, 43" W  
 #RR4S



**4 Way Rack**  
 Two 8 Cube Slant Arms  
 & Two 16" Straight Arms  
 Adjust 50"-71" H, 43" W  
 #RR422

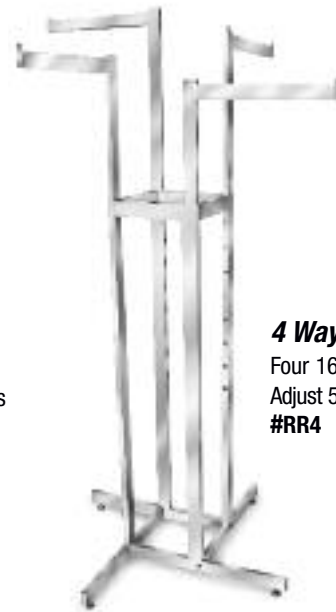

**4 Way Rack**  
 Four 16" Straight Arms  
 Adjust 50"-71" H, 43" W  
 #RR4

## Casters

### 3" Ball Bearing Casters

Set of 4 with 2 Locking  
 #MCC5  $\frac{3}{8}$ " x 1" thread



### Black Twin Locking Caster

#MCC3LOCK  $\frac{5}{16}$ " x 1" thread  
 #MCC4LOCK  $\frac{3}{8}$ " x 1" thread



#MCC3LOCK

#MCC4LOCK

# Rolling Garment Racks

## Nestable Garment Racks

70"H x 60"L Made of 1 1/4" tubing with 4" industrial casters. Racks can nest together for easy storage.

### Hangbar Clamp

For 1 1/4" Tubing  
#MCLAMP2

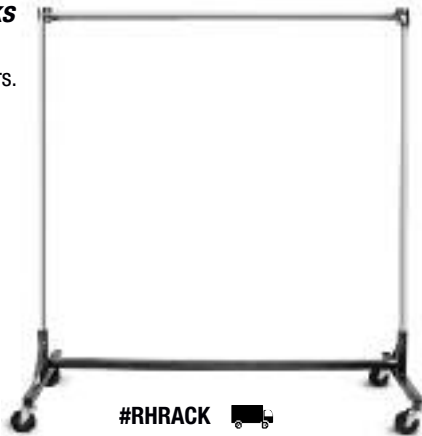

#RHRACK



#RZRACK

### 4" Ball Bearing Caster

Replacement Caster with nut  
#RZRACK2/WHEEL



#RZRACK2

## Collapsible Garment Racks

Folds flat in seconds without tools. 48" long hangrail with two 12" pullouts. Heavy duty 4" casters.

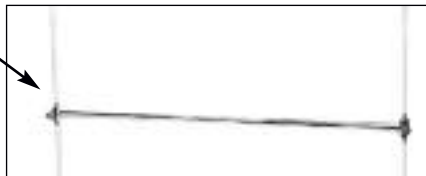

Add-On Bar for Collapsible Racks  
#RSWF-AO

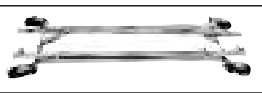

**Double Round Tubing Rack**  
Adjust 56"-65" H, 21" W  
#RSWF/DBL

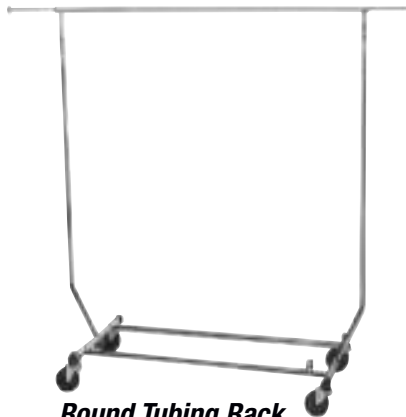

**Round Tubing Rack**  
Adjust 58"-65" H, 23" W  
#RSWF



**Square Tubing Rack**  
Adjust 58"-65" H, 23" W  
#RSWFsq

## All Welded Utility Rack

With heavy duty 4" casters. Powdercoated gray.

60" Long x 66" High

#RWR5

72" Long x 72" High

#RWR6



## 4" Ball Bearing Caster

Replacement Caster with nut  
#M4C

(for all racks on this page except #RK43)



## Single Hangrail Rolling Rack

Adjustable from 54" to 74" high, 60" long x 20" wide.

#RK43



Must ship Common Carrier



# Ladder Systems Wall Units & Displayers



## Single Two Tier Wall Unit

16" wide x 48" long x 88" high.  
Includes two hangrails  
Available in Black & White  
#QA304B



## Double Two Tier Wall Unit

16" wide x 96" long x 88" high.  
Includes four hangrails  
Available in Black & White  
#QA305B



## Tower Ladder Units

14" wide x 73" high with 18" x 22" base  
Available in Black & White  
#QA306B



## Double Center Floor Rack

28" wide x 48" long x 58" high  
Available in Black only  
#QA301B

## Interior Shelves

Available in Black & White  
#QAT77B



## 48" Hangrail

to fit all Ladder units.  
Available in Black & White  
#QARL48B



## Satin Nickel Finish ladder System



## Wall Standard

With Mounting Brackets  
98" H x 5" W  
#R/LD-98

## Hangrail Hooks

#R/LD-H4 4" Hook  
#R/LD-H6 6" Hook  
#R/LD-H9 9" Hook  
#R/LD-H12 12" Hook



## Single Displayer

With casters  
61" H x 24" D  
#R/LD-1



## Double Displayer

With casters  
29 1/4" W x 61" H x 24" D  
#R/LD-2



## Triple Displayer

With casters  
54 1/2" W x 61" H x 24" D  
#R/LD-3

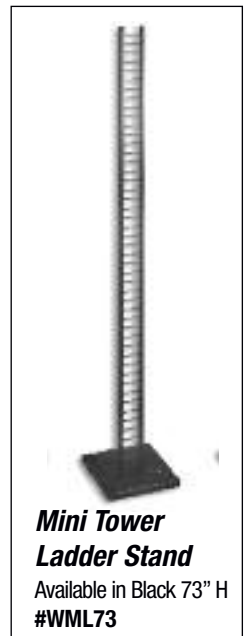

## Mini Tower Ladder Stand

Available in Black 73" H  
#WML73

## U-Shaped Hangrail



#R/LD-HR4  
22 1/2" W x 4" D



#R/LD-HR12  
22 1/2" W x 12" D

#R/LD-SHF14  
Hangrail with Shelf  
22 1/2" W x 14" D

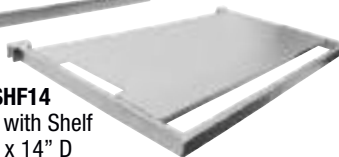

## 12" Faceout

#R/LD-RH12



## 7 Ball Waterfall

#R/LD-RH7B



## Gooseneck Displayer

#R/LD-GND



# Industrial Style Pipe System



**U-Shaped Hangrail**

24"W x 12"D

#RPL/HR24



**Round Rack**

42"W x 42"D x 42"Dia.

Adjusts 48" - 72"H

#RPL/RR42

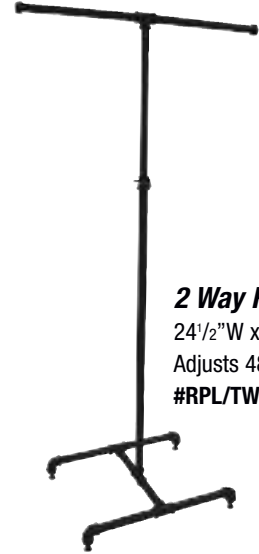

**2 Way Rack**

24 1/2"W x 18 1/2"D

Adjusts 48" - 72"H

#RPL/TW24



**Outrigger**

90"H x 3 1/2"D

#RPL/UPRP90



**Single Rack**

43"W x 32 1/2"D

Adjusts 48" - 72"H

#RPL/SR43

Your Choice of casters can be purchased in place of levelers

**3" Ball Bearing Casters**

Set of 4 with 2 Locking

#MCC5 3/8"x 1" thread



**Black Twin Locking Caster**

#MCC4LOCK 3/8"x 1" thread



**Double Rack**

48"W x 30"D

Adjusts 48" - 72"H

#RPL/DR48



**4 Way Rack**

30"W x 30"D

Adjusts 48" - 72"H

#RPL/FW30



**Large Nesting Table**

60"W x 32"D x 30"H

With Maple Melamine Top

#RPL/TD60

**Small Nesting Table**

48 5/8"W x 23 5/8"D x 24"H

With Maple Melamine Top

#RPL/TD48

# Designer 400 Series



### Island Merchandiser

Rack Frame made of 1" Square Tubing with 16 Shelf Brackets (holds 8 shelves), 2-36" Chrome 1/4" Round Hangrails and Levelers.

Frame Only, Shelves Sold Separately.

#K411MAB Matte Black

Shelves of your choice from the following:

Item #	Color
#WDA224B	Black Shelves
#WDA224AL	Almond Shelves
#WDA224W	White Shelves

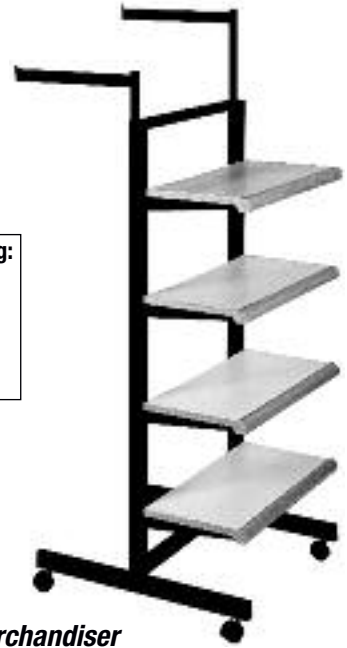

### Rolling Merchandiser

Rack Frame made of 1" x 2" Rectangular Tubing, Matte Black Finish, 2 Straight Arms, 8 Shelf Brackets (holds 4 shelves) and Casters. Frame Only, Shelves Sold Separately.

#K400MAB

## Milano System - In Stock Items



### Rolling Wall Merchandiser

Frame with 2 hangrails.  
48" L x 17" D x 96" H  
#MN306SN 

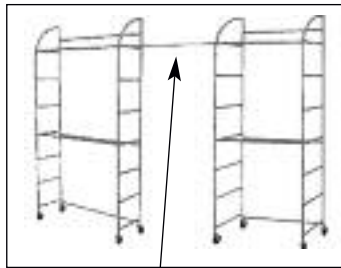

### 48" Handrail

Connects 2 wall units together to make a 12 foot display

#MNHR48SN



### Rolling Merchandiser

Rack Frame made of 1" Square Tubing with Matte Black Finish, 8 Shelf Brackets (holds 4 shelves) and Casters.

Frame Only, Shelves Sold Separately.

#K410MAB

# Bauhaus Series

## Display Racks

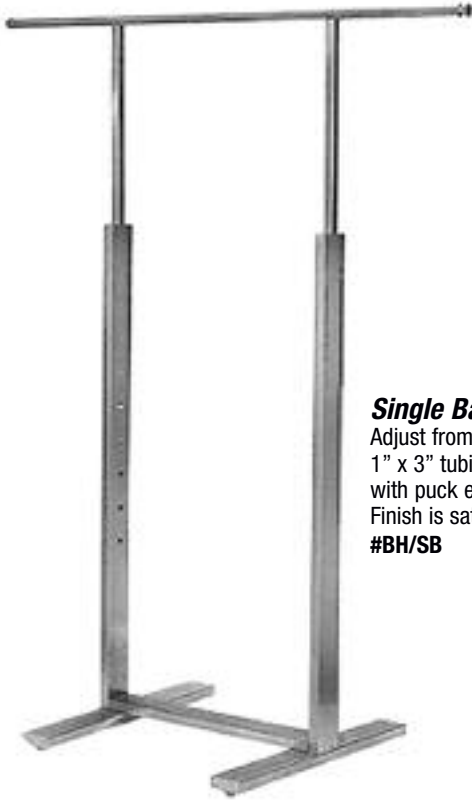

### **Single Bar Merchandiser**

Adjust from 48" to 72" Uprights are 1" x 3" tubing. Handrail is 1 1/4" Dia. x 48" L with puck ends, levelers included. Finish is satin chrome

#BH/SB

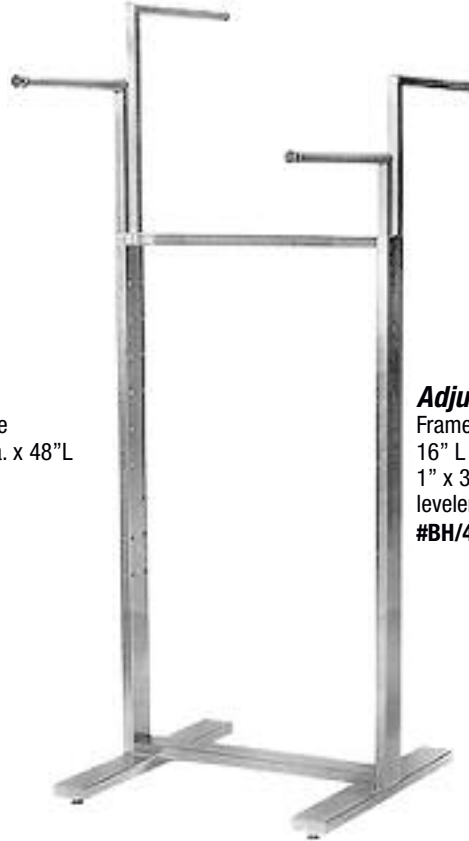

### **Adjustable Four Way Rack**

Frame height 46" min to 75" Arms are 16" L x 1" round with puck ends Upright is 1" x 3" Tubing Base is 24" x 24" levelers included. Finish is satin chrome

#BH/4

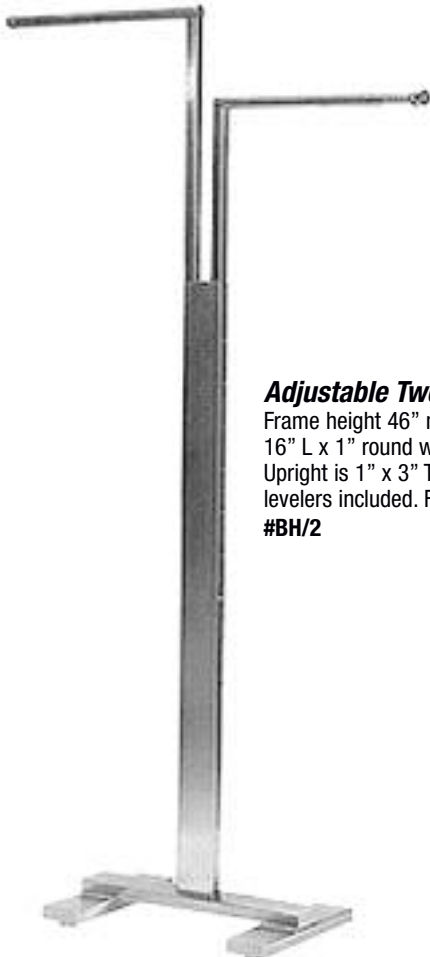

### **Adjustable Two Way Rack**

Frame height 46" min to 75" Arms are 16" L x 1" round with puck ends Upright is 1" x 3" Tubing Base is 24" x 24" levelers included. Finish is satin chrome

#BH/2



### **Adjustable Costumer**

Height 74" Upright is 1" x 3" Tubing with holes at 72", 60", 48" and 36" from floor. Includes 26" x 1" Dia. faceouts with puck ends and levelers. Finish is satin chrome

#BH/AC

# Alta System

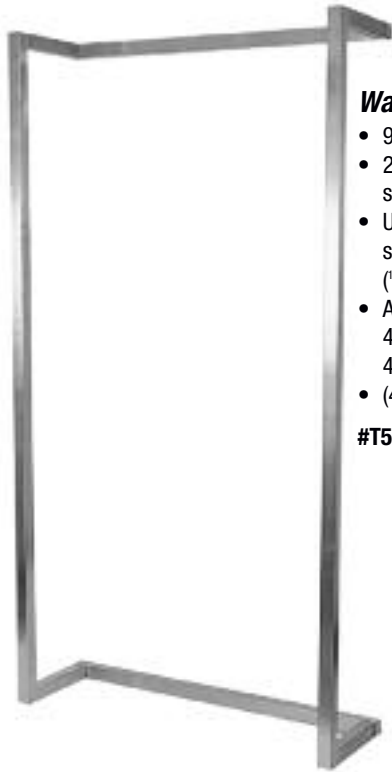

## Wall Module Frame

- 96" H x 50" W x 16"D
- 2"square satin chrome steel tubing
- Universal, rear double-slotted uprights (1/2" slots on 1" centers.
- Accept rear-mounted 48" x 12" selves and 48" L hangrails
- (4) Adjustable levelers

#T500SC



## Cross Merchandiser 4-way

- Includes (8) 11 3/4" x 12" x 3/4" thick MDF/Melamine shelves in Hard Rock Maple finish
- Uniquely flexible merchandiser combining (4) display arms, (8) shelves and built-in graphics frame
- 44" L x 24"W x 72"H
- (4) 16" rectangular arms with stops adjustable form 45" to 72" in height (every 3")
- 12" x 12" sign frame
- 2"square steel tubing inner core and sign frame steel tubing
- Universal, rear double-slotted uprights(1/2" slots on 1" centers)
- (4) Adjustable levelers

#T502SC-H

## Wall Module Accessories



### 7 Ball Waterfall

Satin Chrome  
#WRH7BSC



### 12" Rectangular Bracket

Satin Chrome  
#WCR12SC

### 3" Rectangular Bracket

Satin Chrome  
#WCR3SC



### 12" Straight Arm

Satin Chrome  
#WRH12SC



## Island Multi Merchandiser

- Bold, 2 sided merchandiser with a generous top shelf for displays, forms or signage. use shelves, hangrails or both
- 48" L x 34" W x 54" H
- 2"square satin chrome steel tubing
- Universal, rear double-slotted uprights (1/2" slots on 1" centers)
- Accepts rear-mounted 48" x 12" shelves
- 4 Adjustable levelers

#T503SC-H

## Rectangular Tubing End Cap

Extended. Satin Chrome  
#WRKEXTSC



## 4' Rectangular Tubing

Satin Chrome  
#WRT4SC

# Chainlix Display System-Special Order Items FOB Factory

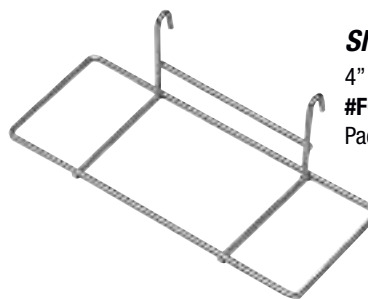

**Shoe Displayer**  
4" x 10"  
#FC410EC  
Packed 12 per carton



**Hooks**  
#FCH4EC 4" Hook  
#FCH6EC 6" Hook  
#FCH8EC 8" Hook  
Packed 24 per carton

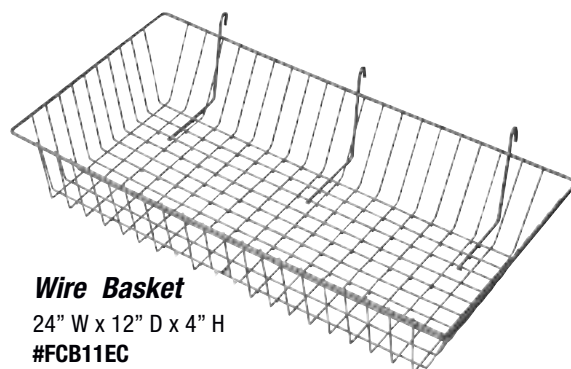

**Wire Basket**  
24" W x 12" D x 4" H  
#FCB11EC  
Packed 6 per carton



**Hangrail Bracket**  
3" Deep  
#FC203EC  
Packed 12 per carton



**Hangrail Bracket**  
10" Deep  
#FC210EC  
Packed 12 per carton



**Round Hangrail**  
#RY2BR  
1 1/4" x 24" brushed chrome  
Packed 10 per carton  
#RY4BR  
1 1/4" x 48" brushed chrome  
Packed 10 per carton



**12" Faceout**  
1/2" slots on 1" center  
#FC12EC  
Packed 12 per carton



**12" Shelf bracket**  
#FGB12EC  
Packed 25 per carton



**16" Faceout**  
for FCR104EC Rack  
#FCS16EC  
Packed 24 per carton



**3" Face-Out**  
#FC3EC  
Packed 12 per carton



**Wall bracket**  
#FCWEC  
Packed 24 per carton



**Joining Clip**  
for joining 2 panels  
#FJCEC  
Packed 24 per carton



**7 Ball Waterfall**  
1/2" slots on 1" center  
#FC7BEC  
Packed 12 per carton

# Chainlix Display System-*Special Order Items FOB Factory*

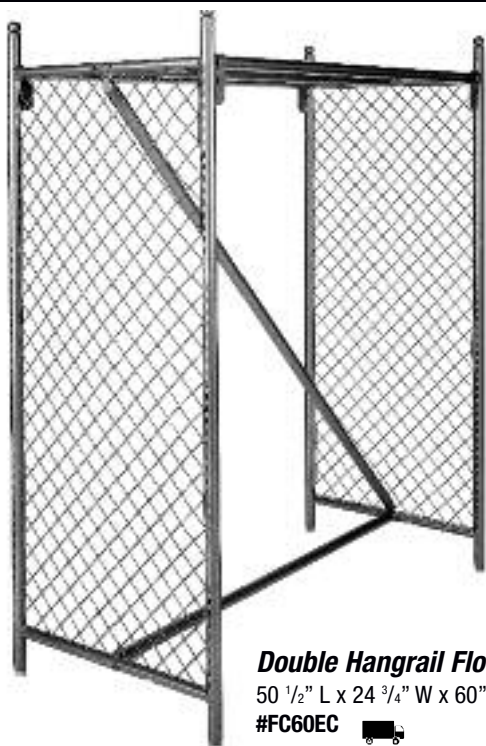

### **Double Hangrail Floor Rack**

50 1/2" L x 24 3/4" W x 60" H

#FC60EC 

Packed 1 per carton



### **Gondola Floor Rack**

1/2" slots on 1" center

Slots on both sides of uprights

50 1/2" L x 25" W x 61" H

#FC61EC

Packed 1 per carton

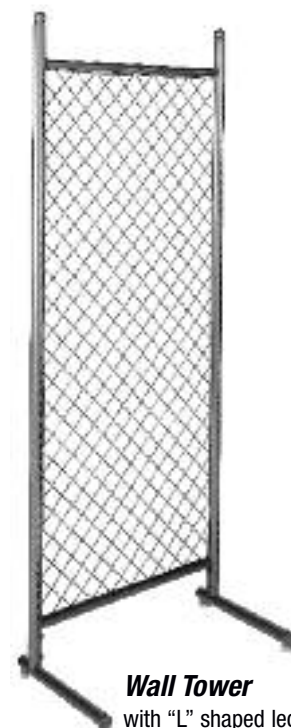

### **Wall Tower**

with "L" shaped legs for placement against wall  
24 3/4" W x 73" H

#FCLG74EC

Packed 1 per carton

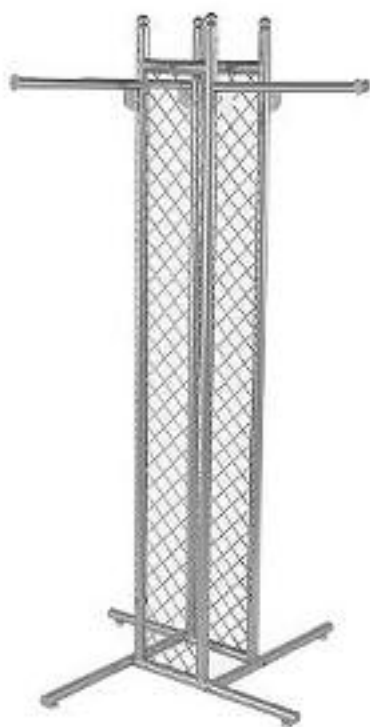

### **4-Way Floor Rack**

70 1/2" H Four 16" faceout arms.

1/2" slots on 1" center.

Panel is 10" wide.

Adjustable levelers included.

#FCR104EC

Packed 1 per carton



### **Panels**

Panels can be hung on wall with brackets or self standing with joining clips

24 3/4" W x 72" H

#FC74EC Packed 1 per carton

24 3/4" W x 96" H

#FC96EC Packed 1 per carton

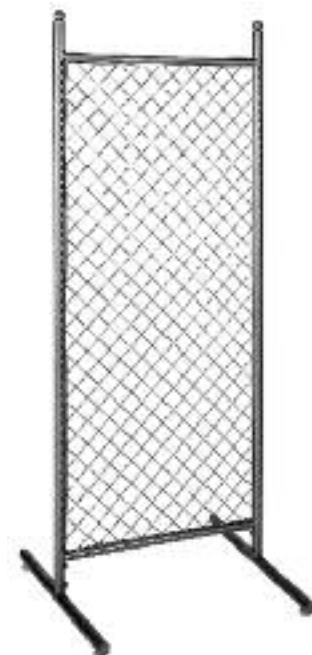

### **Freestanding Panel**

with "T" legs

#FCL62EC

24 3/4" W x 62" H

Packed 1 per carton

#FCL73EC

24 3/4" W x 73" H

Packed 1 per carton



# Public Guidance Traditional System - FOB Factory



### Regal Post

- #2010-10 Chrome
- #2010-00 Polished Brass
- #2010-44 Satin Stainless Steel

### Crown Post

- #2060-10 Chrome
- #2060-00 Polished Brass
- #2060-44 Satin Stainless Steel

Other post finishes available on request  
(one week lead time)

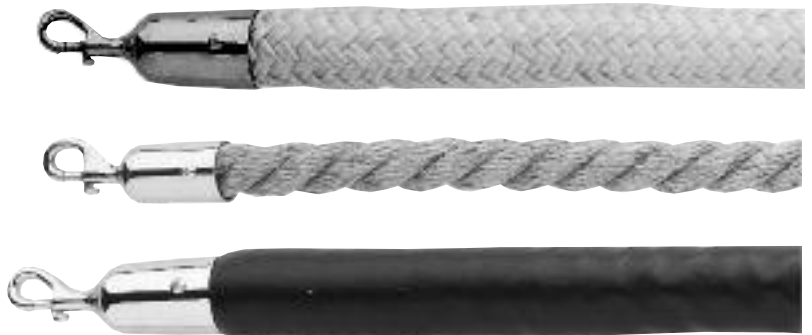

- #60-151/1H Braided Rayon Rope
- #60-151/1H/N Natural Hemp Rope
- #60-160 Vinyl Covered Rope (chain core)
- #60-161 Velour Covered Rope (chain core)
- #60-162 Tweed Covered Rope (chain core)

All rope hooks and snaps are factory attached to ropes unless otherwise specified.

## Economy Public Guidance

**#ST100BLK**  
Black Stantion  
with 7' Retractable Belt

**#STG1160SC**  
Station-satin chrome

**#STG60BK**  
60" black velvet rope with hooks



- #950** Wall Plate
- #930** Rope Snap Hook
- Wall Plate**
- #950-00 Polished Brass
- #950-40 Polished Stainless
- #950-44 Satin Stainless
- Rope Snap Hook**
- #930-00 Polished Brass
- #930-40 Polished Stainless
- #930-44 Satin Stainless



# Public Guidance Beltrac System - FOB Factory



United States Patent No.343690

## Beltrac Post with Belt

This retractable belt system offers the most satisfactory combination of form and function. The accepted standard for most retailers, banks and airlines.

### #ST300BKBK

Beltrac Post with standard 7' Belt with Wrinkle Black finish.

### Beltrac Post

#50-3000/CL Chrome

#50-3000/GD Gold Anodized

#50-3000/SA Satin Chrome Anodized

Other post and belt finishes are available on request, prices may vary.

(please allow 1-2 week lead time)



## Wall Mount Unit

Wall Mount Beltrac with standard 7' belt with wrinkle black finish.

#50-3010CL Chrome

#50-3010GD Gold Anodized

### #50-3011

Wall Receptacle  
Black Only

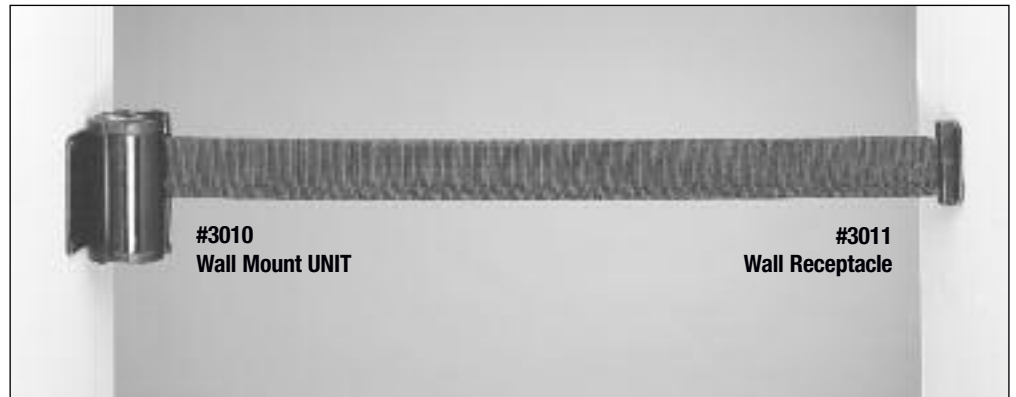
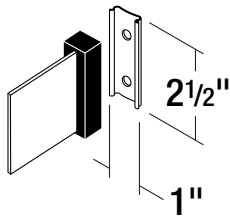
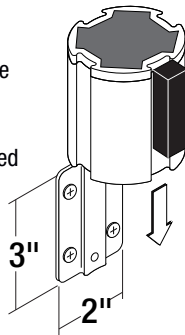

## Sign Frames

Model No.	Horizontal Dimension	Vertical Dimension	Orientation	Finish
50-1130MB	11"	7"	Horizontal	Matte Black
50-1141MB	14"	11"	Horizontal	Matte Black

# Shelves

## Plastic Bullnose Shelves

Open Bottom

Item #	Size	Color
#WDA224AL	13" x 24"	Almond
#WDA224B	13" x 24"	Black
#WDA224M	13" x 24"	Maple
#WDA224W	13" x 24"	White
#WDA248AL	13" x 48"	Almond
#WDA248B	13" x 48"	Black
#WDA248M	13" x 48"	Maple
#WDA248W	13" x 48"	White
#WDA448AL	15" x 48"	Almond
#WDA448B	15" x 48"	Black
#WDA448W	15" x 48"	Maple



## Wood Shelves- LPL

Wooden Shelves

Item #	Size	Color
Must use 10" Shelf Bracket #SSW10BK		
#W1224B-H	11 <sup>3</sup> / <sub>4</sub> " x 24"	Black
#W1224M-H	11 <sup>3</sup> / <sub>4</sub> " x 24"	Maple
#W1224W-H	11 <sup>3</sup> / <sub>4</sub> " x 24"	White
Must use 10" Shelf Bracket #SSW10BK		
#W1248B-H	11 <sup>3</sup> / <sub>4</sub> " x 48"	Black
#W1248M-H	11 <sup>3</sup> / <sub>4</sub> " x 48"	Maple
#W1248W-H	11 <sup>3</sup> / <sub>4</sub> " x 48"	White
Must use 12" Shelf Bracket #SSW12BK		
#W1448B-H	14" x 48"	Black
#W1448M-H	14" x 48"	Maple
#W1448W-H	14" x 48"	White

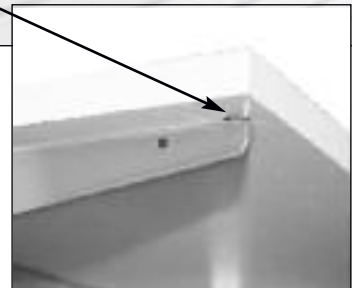
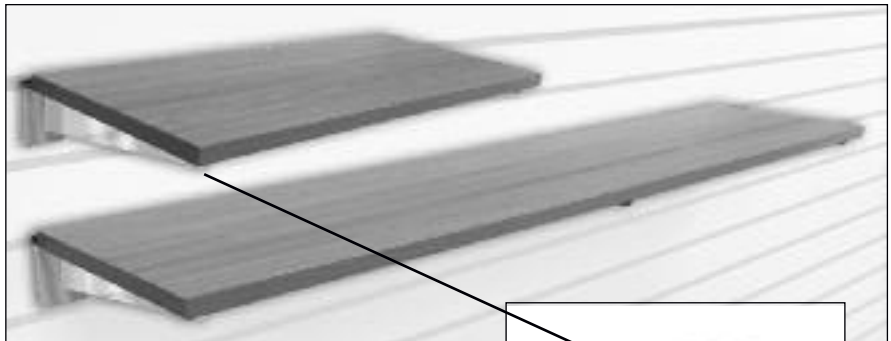

Has holes to conceal shelf bracket



# Knockdown Displays



## Slatwall Gondola

48"W x 24"D x 54"H  
Shipped in 2 cartons.  
Total weight 150 lbs.  
Available in Maple,  
Black, White & Cherry.  
**#JDA/SG4854**   
Available with Metal  
Inserts in Maple and White  
Only.



## Slatwall "T" Display

24"W x 24"D x 54"H  
with 24" wide slatwall panels  
Shipped in 1 carton.  
Total weight 75 lbs.  
Available in Maple, Black  
and White.  
**#JDA/SWT2454**



## Pinwheel Unit

36"W x 36"D x 54"H  
with 24" wide slatwall panels  
Shipped in 2 cartons.  
Total weight 110 lbs.  
Available in Maple, Black,  
White & Cherry.  
**#JDA/PW3654**



## Wood Shelves- LPL

**#JDA/1124** 11" x 23 3/4"  
Must use 10" Shelf Bracket **#SSW10BK**  
Fits **#JDA/PW3654**, **#JDA/SWT2454**  
Available in: Black, White and Maple



**#JDA/1148** 11" x 47 3/4"  
Must use 10" Shelf Bracket **#SSW10BK**  
Fits **#JDA/SG4854**  
Available in: Black, White and Maple



## Tower Unit

24"W x 24"D x 54"H  
Shipped in 1 carton.  
Total weight 104 lbs.  
Available in Maple,  
Black, White & Cherry.  
**#JDA/SC2454**



## Revolving Tower Unit

20"W x 20"D x 54"H  
Shipped in 2 carton.  
Total weight 99.2 lbs.  
Available in Maple,  
Black & White.  
**#JDA/REV20**



## Revolving Tower Unit

12"W x 12"D x 54"H  
Shipped in 2 carton.  
Total weight 58 lbs.  
Available in Maple,  
Black & White.  
**#JDA/REV12**



## Revolving "T-Shirt" Display

24"W x 24"D x 65 1/2"H  
20 T-Shirt compartments  
and 20 lucite T-Shirt displays.  
Shipped in 2 cartons.  
Total weight 209.5 lbs.  
Available in Maple, Black  
and White.  
**#JDA/REV24T**



## 3 Tier Waterfall Table

60"W x 42"D x 42"H  
Carton packed Total weight 190 lbs.  
Available in  
Maple, Black, White & Cherry.  
**#JDA/TTT6042**



## 3 Tier Waterfall Table

48"W x 48"D x 41"H  
Carton packed Total weight 140 lbs.  
Available in  
Maple, Black, White & Cherry.  
**#JDA/TTT4848**

## Knockdown Cubes

Available in Maple, Black, White & Cherry.  
UPS Shippable  
18"W x 18"D x 24"H  
**#JDC/1824**  
18"W x 18"D x 18"H  
**#JDC/1818**  
18"W x 18"D x 12"H  
**#JDC/1812**

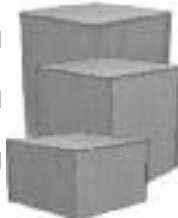

## Knockdown Dump Table

Maple 30"W x 60"L  
3 1/4" Deep table  
with folding legs.  
**#MDUMP2**

# Slatwall Panels & Hardware

## NEW SIZE 18mm MDF Slatwall Panels

### Low Pressure Laminate

Item #	Size	Color	Description
#SF/4894BLK	48" x 94"	Black	3" O.C. Grooves
#SF/4894CHE	48" x 94"	Cherry	3" O.C. Grooves
#SF/4894WHT	48" x 94"	White	3" O.C. Grooves
#SF/4894WHT-INS6	48" x 94"	White	6" O.C. Grooves with Metal Inserts



## 18mm MDF Slatwall Panels

### Low Pressure Laminate

Item #	Size	Color	Description
#SF/48BLK	48" x 96"	Black	3" O.C. Grooves
#SF/48BLK-INS3	48" x 96"	Black	3" O.C. Grooves with Metal Inserts
#SF/48BLK-INS6	48" x 96"	Black	6" O.C. Grooves with Metal Inserts
#SF/48CHE	48" x 96"	Cherry	3" O.C. Grooves
#SF/48CHE-INS3	48" x 96"	Cherry	3" O.C. Grooves with Metal Inserts
#SF/48GRY	48" x 96"	Grey	3" O.C. Grooves
#SF/48GRY-INS3	48" x 96"	Grey	3" O.C. Grooves with Metal Inserts
#SF/48MAP	48" x 96"	Maple	3" O.C. Grooves
#SF/48MAP-INS3	48" x 96"	Maple	3" O.C. Grooves with Metal Inserts
#SF/48MAP-INS6	48" x 96"	Maple	6" O.C. Grooves with Metal Inserts
#SF/48PG	48" x 96"	Paint Grade	3" O.C. Grooves
#SF/48SILV-INS3	48" x 96"	Silver	3" O.C. Grooves with Metal Inserts
#SF/48WHT	48" x 96"	White	3" O.C. Grooves
#SF/48WHT-INS3	48" x 96"	White	3" O.C. Grooves with Metal Inserts
#SF/48WHT-INS6	48" x 96"	White	6" O.C. Grooves with Metal Inserts

## 19mm MDF Slatwall Panels- Call for Pricing

Paint Grade
Mirrored
<b>Low Pressure Laminate</b>
White
Grey, Platinum & Almond
Maple, Oak & Anigre
Cherry
Brushed Silver
Black
<b>High Pressure Laminate</b>
Standard Formica & Wilson Art laminates
<b>Wood Veneers</b>
Red Oak, Maple & Birch



### Metal Slatwall Hooks

Available in Chrome, Black, White or Raw Steel.

Item #	Size
#SNHK*	Single Notch
1/4" Heavy Duty	
#SSWH1	1" Long
#SSWH4	4" Long
#SSWH6	6" Long
#SSWH8	8" Long
#SSWH10*	10" Long
#SSWH12*	12" Long
3/16" Economy	
#SSWHX1*	1" Long
#SSWHX4*	4" Long
#SSWHX6*	6" Long
#SSWHX8*	8" Long
#SSWHX10*	10" Long
#SSWHX12*	12" Long

\*Not available in Raw Steel

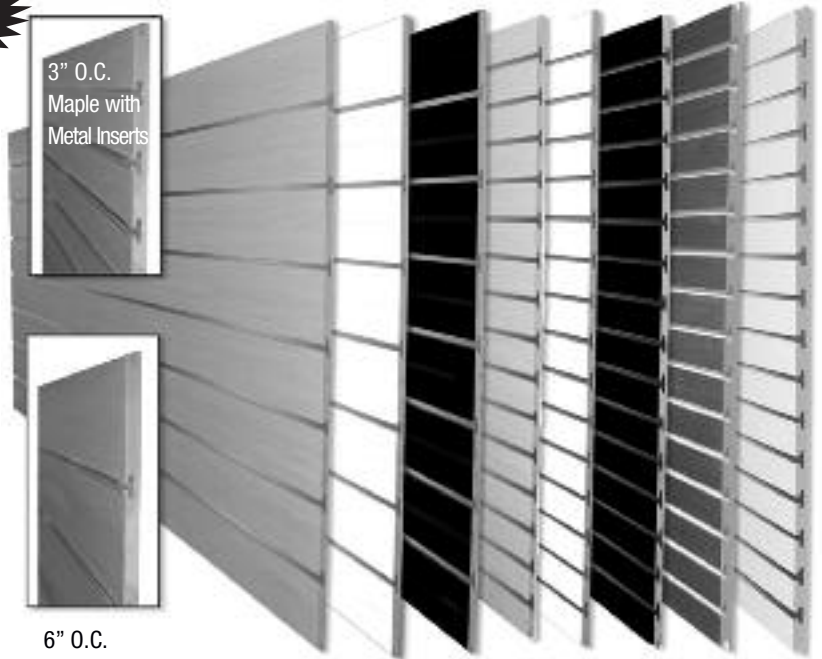

6" O.C.  
Maple with  
Metal Inserts

4' High x 8' Wide  
6" O.C. Grooves

4' High x 8' Wide  
3" O.C. Grooves

48" High x 94" Wide  
6" O.C. Grooves

48" High x 94" Wide  
3" O.C. Grooves



### Hat Display

Available in Chrome, Black, White or Raw Steel.

- #SHAT Chrome
- #SHATB Black
- #SHATW White

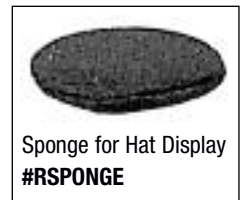

Sponge for Hat Display  
#RSPONGE

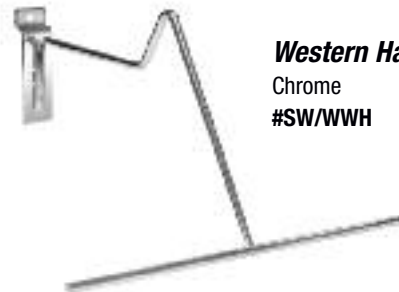

### Western Hat Display

Chrome  
#SW/WWH



### Cap holder

Available in Chrome & Black

- #SWCAP Chrome
- #SWCAP/B Black

# Slatwall Hardware



## 6 Ball Waterfall

Square Tubing

Available in Chrome, Black and White

- #SSW6B Chrome
- #SSW6BB Black
- #SSW6BW White



## 5 Hook Waterfall

Square Tubing

Available in Chrome, Black and White

- #SSW5H Chrome
- #SSW5HB Black
- #SSW5HW White



## Straight Arm

12" Square Tubing

Available in Chrome, Black and White

- #SSW12 Chrome
- #SSW12B Black
- #SSW12W White



## 7 Ball Waterfall

Rectangular Tubing

Available in Chrome, Black, White & Raw Steel.

- #SRW7B Chrome
- #SRW7BB Black
- #SRW7BW White
- #SRW7BR Raw Steel

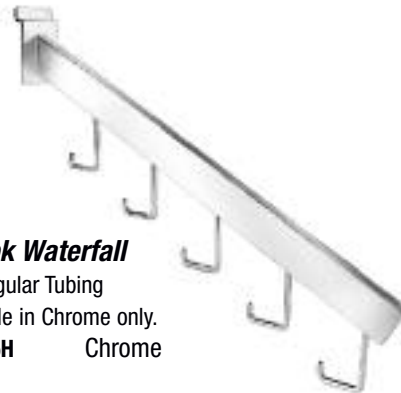

## 5 Hook Waterfall

Rectangular Tubing

Available in Chrome only.

- #SRW5H Chrome



6" Rectangular Tubing

Available in Chrome only.

- #SRW6 Chrome



**NEW ITEM**

## Wood Shelf Brackets

Two 11" Slatwall Shelf Bracket

Available in Chrome only.

- #SW8111 Chrome



## Single Garment Hook

With 3" disc end.

- #SSWFRC Chrome
- #SSWFRB Black



## Straight Arms

12" Rectangular Tubing

Available in Chrome, Black, White & Raw Steel.

- #SRW12 Chrome
- #SRW12B Black
- #SRW12W White
- #SRW12R Raw Steel



## Glass Shelf Brackets

Available in Chrome, Black, White or Raw Steel

Item #

- #SSW8KB\* For 8" Glass
- #SSW10KB\* For 10" Glass
- #SSW12KB For 12" Glass
- #SSW14KB For 14" Glass
- #SSW16KB\*\* For 16" Glass

\*Not available in Raw Steel.

\*\*Available only in Chrome.

# Slatwall Hardware & Displays



## Hangrail Brackets

For Rectangular Tubing Hangrail.

For slatwall with metal inserts only.

- #SSW33 3" Chrome
- #SSWFB 12" Chrome
- #SSWFBB 12" Black
- #SSWFBR 12" Raw Steel

## Round Tubing "U" Hangrail

24"W x 12"D

#SW681/C Chrome

#SW681/B Matte Black\*

\*With Flat Chrome Strip



## Chrome Hangrail Bracket

For round tubing hangrail. Available in Chrome

For slatwall with metal inserts only.

#SSWRM fits 1 1/16" tubing

#SSWRT\* fits 1 1/4" tubing

\*Also available in Black



## Reinforced Hangbar Bracket

For 3" & 6" O.C. slatwall only.

Chrome

#SSWFB/REIN

## Slatwall Displays



### Literature Holder

#SCH 24" long

#SCH48 48" long

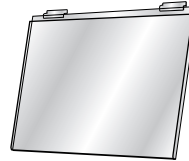

### Sign Holders

#SFRAME 3 1/2"W x 5 1/2"H

#SFRAME1 7"W x 5 1/2"H

#SFRAME2 11"W x 7"H

#SFRAME4 8 1/2" W x 11"H



### Slatwall Display Case

with lock and 2 removable shelves.

13"W x 21"H x 7 1/2"D

#S2466

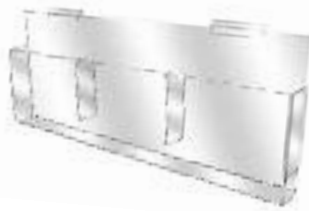

### Lucite Brochure Holder

3 pocket.

26 1/2"W x 10 1/8"H x 2 1/4"D

#S2454



### Literature & Video Display

4 tier.

#S2216



### Lucite T-Shirt Display Frame

11 1/2"W x 15"H

#STSHIRT1



### Slatwall Display Case

with lock.

21"W x 13"H x 7 1/2"D

#S2468



### Brochure Holder

3 tier, 6 pocket.

For 8 1/2" W x 11" H literature.

#S2119



### Video & Greeting Card Holder

3 tier.

21"W x 11"H x 6"D

#S2349

Lucite items require special packaging. A \$5.00 fee per shipping carton will be automatically added to your order.

# Lucite Slatwall Shelves & Accessories



#SJMS410



#SJMS612

## Shoe and Utility Shelves

Styrene Utility Shelf

#SJMS410 10"W x 4"D

#SJMS612 12"W x 6"D

Styrene Shoe Shelf With Sign Holder

#SJMS4SL 10"W x 4"D



#SJMS4SL



**Lucite  
Display Hanger**  
#SHGR



## Slant Shoe Shelf

Lucite.

4"W x 10"L

#S10SL1



## Left Slant Shoe Shelf

with toe stop. Lucite.

4"W x 10"L

#S10L



## Right Slant Shoe Shelf

with toe stop. Lucite.

4"W x 10"L

#S10R



## Slanted Shelf

24"W x 11"D

#S1224SL



## Straight Shelf

24"W x 12"D

#S1224

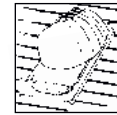

## Plastic Slatwall Cap Rack

Clear Plastic Shelf with 1 5/8" lip.

6 1/2"W x 12 1/2"D

#S1762HAT



## Hosiery Bin

1 bin. 7"W x 4"H x 4"D

#S2420

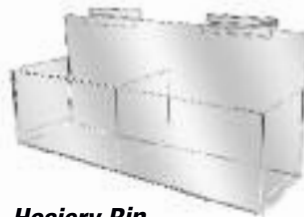

## Hosiery Bin

2 bin. 14"W x 4"H x 4"D

#S2421



## Divided Lucite Hosiery Bin

3 bin. 24" W x 4"H x 6"D

#STRAY

## Lucite Slatwall Mirror

8"W x 10"H

#S2062

10"W x 14"H

#S2064



## Clutch Bag Display

4"W x 4"H x 16"L

#S2090



## Lucite Necklace & Bracelet Display

12"W

#SNECK

Lucite items require special packaging. A \$5.00 fee per shipping carton will be automatically added to your order.

# Gridwall & Slatwall Baskets

## Shallow Basket

Available in Chrome, Black & White

24"W x 4"H x 12"D

#GSG/BK1C Chrome

#GSG/BK1B Black

#GSG/BK1W White



## Double Sloping Basket

Available in Black & White

24"W x 5"H x 10"D

#GSG/BK2B Black

#GSG/BK2W White



## Double Sloping Basket

Available in Black Only

12"W x 4"H x 12"D

#GSG/BK3B Black



## Deep Basket

Available in Chrome & Black

12"W x 8"H x 12"D

#GSG/BK5C Chrome

#GSG/BK5B Black



## Sloping Basket

3" High in front.

Available in Chrome & Black

15"W x 5"H x 12"D

#GSG/BK6C Chrome

#GSG/BK6B Black



## Narrow Basket

Available in Chrome, Black & White

12"W x 6"H x 6"D

#GSG/BK7C Chrome

#GSG/BK7B Black

#GSG/BK7W White



## Slatwall Basket

24"W x 6"H x 12"D

#SBASKCH Chrome

#SBASKBL Black



## Grid Basket

24"W x 6"H x 12"D

#GBASKCH Chrome

#GBASKBL Black

#GBASKWH White



## Slatwall Shelf

24" W x 12"D

#SSHELFC Chrome

#SSHELFB Black

#SSHELFW White



## Grid Shelf

24" W x 12"D

#GSHELFC Chrome

#GSHELFB Black

#GSHELFWH White











# Gridwall & Accessories

## Gridwall Panels

Available in Chrome, White and Black

Item #	Size	Packed
#GW24	2' x 4'	3
#GW25	2' x 5'	3
#GW26	2' x 6'	3
#GW27	2' x 7'	3 
#GW28	2' x 8'	3 
#GW36	3' x 6'	3 
#GW44	4' x 4'	3 
#GW48	4' x 8'	2 

Available in Raw Steel

#GR/26	2' x 6'	3
#GR/28	2' x 8'	3 

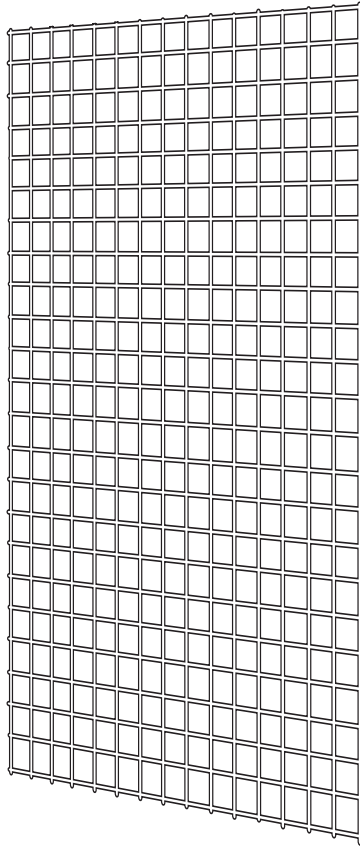

## Gridwall Single Notch Hooks

Available in Chrome, Black & White

Item #  
#GNHK



## Gridwall Hooks

Available in Chrome, White and Black

Item #	Size
#GH1	1"
#GH4	4"
#GH6	6"
#GH8	8"
#GH10	10"
#GH12	12"

Available in Raw Steel

Item #	Size
#GH4R	4"
#GH6R	6"
#GH8R	8"



## Gridwall Wall Bracket

Available in Chrome, White and Black



Item #  
#GWB

Available in Raw Steel  
#GR/WB

## Slatgrid

Fits Gridwall and Slatwall Accessories.

Available in Black, White and Chrome.

Item #	Size	Packed
#GSG24	2' x 4'	3
#GSG25	2' x 5'	3
#GSG26	2' x 6'	3
#GSG27	2' x 7'	3 
#GSG28	2' x 8'	3 

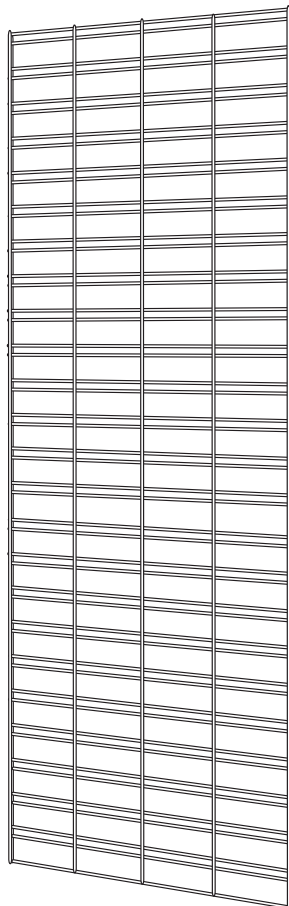

## Gridwall Joiner Clamp

Available in Chrome, White and Black

Item #  
#GJC

# Gridwall Hardware



### **Straight Arm**

12" Long.

#GGW12 Chrome  
#GGW12B Black  
#GGW12W White



### **Waterfall**

#GWF Chrome  
#GWFB Black  
#GWFW White



### **5 Hook Waterfall**

#GWH Chrome  
#GWHB Black  
#GWHW White



### **Rectangular Tubing Straight Arm**

12" long.  
#GRG12B Black  
#GR/RG12 Raw Steel



### **Glass Shelf Bracket**

#G4110 10" Black  
#G4112 12" Black, White & Chrome  
#G4114 14" Black & Chrome



### **Rectangular Tubing Hangrail Bracket**

12" Long.  
#GRT Chrome  
#GRTB Black



### **Round Tubing Hangrail Bracket**

12" Long  
#GHRA fits 1 1/16" tubing Chrome  
#GHRB fits 1 1/4" tubing Chrome  
#GHRBB fits 1 1/4" tubing Black



### **Rectangular Tubing Waterfall**

#GRG7 Chrome  
#GRG7BLK Black  
#GR/RG7 Raw Steel



### **3" Single Garment Hook**

#GGWFRC Chrome  
#GGWFRB Black

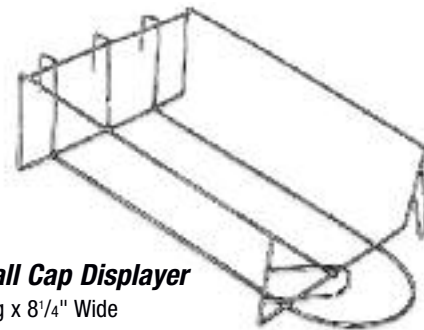

### **Gridwall Cap Displayer**

14" Long x 8 1/4" Wide  
#GWCAP Chrome  
#GWCAP/B Black

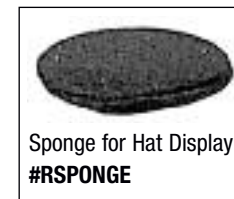

Sponge for Hat Display  
#RSPONGE

### **Hat Display**

#GHAT Chrome  
#GHATB Black  
#GHATW White

# Gridwall Hardware, Shelves & Accessories

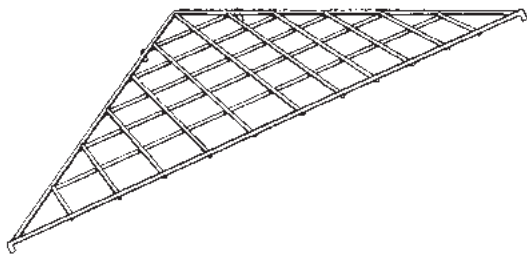

### Triangular Grid Shelf

Available in Black & Chrome

#GGWS90B Black

#GGWS90C Chrome

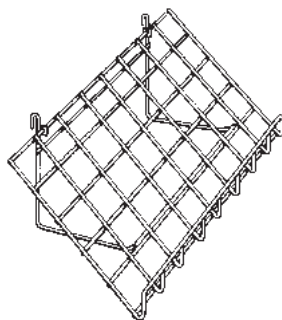

### Slant Shelf with Front Lip

24"W x 15"D

Available in Black only.

#GGWS91B

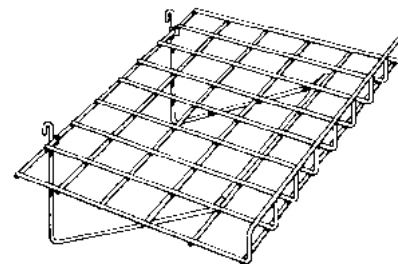

### Flat Shelf with Front Lip

24"W x 15"D

Available in Black

#GGWS93B Black



### "Scarecrow" Gridwall Display

Available in Black only.

#GSCAREB

### Round Tubing "U" Hangrail

24"W x 12"D

#GKHG681

Chrome

#GKB681

Black



### Quarter Round Hangrail

Available in Chrome & Black

#GKHG680 Chrome

#GKHG680B Black

### Grid Shoe Shelves

8"W x 4"D Lucite Shoe Shelf

#G3001

10"W x 4"D Styrene Shoe Shelf

#G3002

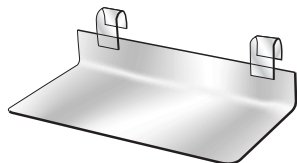

### Double Lucite Gridwall Brochure Holder

Holds 8 1/2"W x 11"H literature.

#G3452

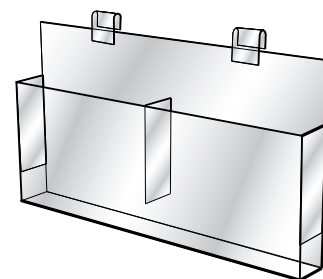

### Lucite Gridwall Cardframe

#GFRAME1 7"W x 5 1/2"H

#GFRAME2 11"W x 7"H

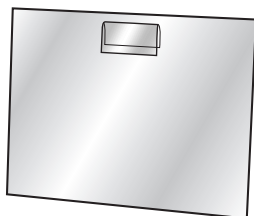

### Gridwall T-Shirt Display Frame

11 1/2"W x 15"H

includes folding board.

#GTSHIRT1



Lucite items require special packaging. A \$5.00 fee per shipping carton will be automatically added to your order.

# Grid Bases & Stands

## ***Pinwheel Dolly on Wheels***

Holds four 24" gridwall or slatgrid.  
Mounting hardware included.

Available in Black & White

#G4DOLBK Black

#G4DOLWH White

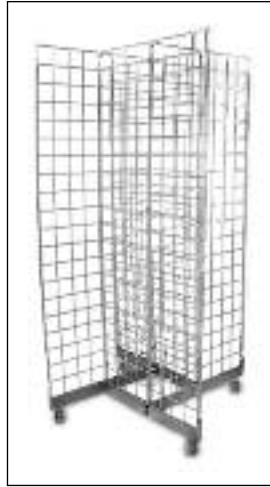

## ***Triangle Dolly on Wheels***

Holds three 24" gridwall or slatgrid.

Available in Black & White

#G3DOLBK Black

#G3DOLWH White

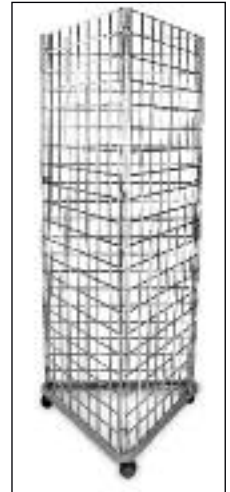

## ***Grid Base***

Freestanding base for gridwall or slatgrid.

Mounting hardware included.

Available in Chrome, Black,  
White & Raw Steel

#GBASE Chrome

#GBASEB Black

#GBASEW White

#GR/BASE Raw Steel

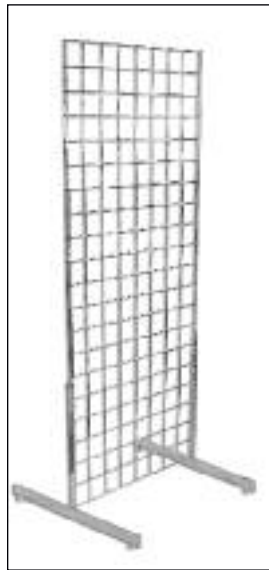

## ***Gondola Grid Base***

Use to form gridwall gondola units.

Holds four 24" gridwall or slatgrid.

Mounting hardware included.

Available in Chrome, Black & White

#GWG48C Chrome

#GWG48B Black

#GWG48W White

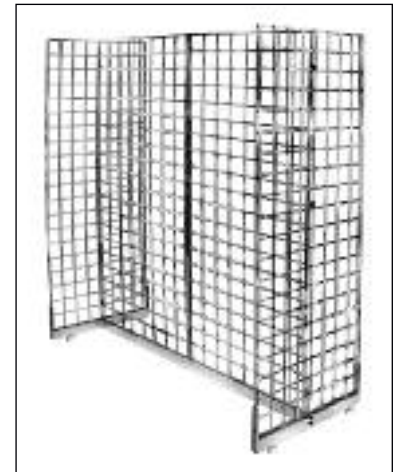

# Wire Shelving



## Post - 2 Section Construction

Packed 4 per carton\*

Item #	Size
#MS/UR34C-2	34" Height
#MS/UR54C-2	54" Height
#MS/UR63C-2	63" Height
#MS/UR74C-2	74" Height
#MS/UR86C-2	86" Height



## Post Clamp

Used to connect 2 posts.

Packed 250 per carton

#MS/PC

## Heavy Weight Wire Shelves

Packed 4 per carton\*

Item #	Size
#MS/1824C	18" x 24"
#MS/1836C	18" x 36"
#MS/1848C	18" x 48"
#MS/1860C	18" x 60"
#MS/1872C	18" x 72"
#MS/2436C	24" x 36"
#MS/2448C	24" x 48"
#MS/2460C	24" x 60"
#MS/2472C	24" x 72"



## "S" Hook

Used to add-on shelves to existing units. Saves the cost of 2 posts.

Packed 1000 per carton

#MS/SH



#MS/BSK5



#MS/BSK10



#MS/BSK15

## Wire Baskets

Hangs on shelf edge.

Packed 10 per carton\*

#MS/BSK5	7" H x 13" W x 5" D
#MS/BSK10	5" H x 17" W x 7" D
#MS/BSK15	10" H x 17" W x 7" D



## Triangle Shelves

Packed 10 per carton\*

#MS/TS14 14"W

#MS/TS18 18"W



## Quarter Round Shelves

Packed 4 per carton\*

#MS/SS14C 14"W

#MS/SS18C 18"W

#MS/SS24C 24"W



## Garment Hanger Tube

with Brackets.

Packed 20 per carton\*

#MS/HR-36 36" L

#MS/HR-48 48" L

#MS/HR-60 60" L

# Universal Standards & Brackets

## Shelf Brackets



### Wood Shelf Brackets

- #W8112 12"
- #W8114 14"
- #W8116 16"



### Glass Shelves Brackets

- #W418 8"
- #W4110 10"
- #W4112 12"
- #W4114 14"
- #W4116 16"



### Adjustable Angle Glass Shelf Brackets

- #W4312 12"



### Glass Shelf Rest with Rubber Buttons.

#W432

## Straight Arms & Waterfalls

### 12" Straight Arm

Chrome Square Tubing  
Universal Standard Mount  
#WTS12



### 12" Straight Arm

Chrome Rectangular Tubing  
Universal Standard Mount  
#WRDW12

### Universal Standards

Single Slotted  
with 1/2" slots 1" centers

- #W404 4 feet
- #W405 5 feet
- #W406 6 feet
- #W407 7 feet
- #W408 8 feet



### Multi-Ball Waterfall

Chrome Square Tubing  
Universal Standard Mount  
#WTS7B 7 Ball  
#WTS5B 5 Ball

## Hangrail Brackets



### 12" Round Hangrail Bracket

Chrome. For Round Tubing.  
Universal Standard Mount  
#WA112 fits 1 1/16" tubing  
#WA212 fits 1 1/4" tubing

### 2 1/2" Round Hangrail Bracket

Chrome. For Round Tubing.  
Universal Standard Mount

- #W8537A fits 1 1/16" tubing
- #W8537B fits 1 1/4" tubing
- #W8537AR fits 1 1/16" tubing in Raw Steel



### 12" Rectangular Tubing Bracket

Chrome. For Rectangular Tubing.  
Universal Standard Mount  
#WCR12 Chrome  
#WCR12MAB Matte Black  
#WCR12R Raw Steel  
#WCR12SC Satin Chrome



### 3" Rectangular Tubing Bracket

Chrome. For Rectangular Tubing.  
Universal Standard Mount

- #WCR3 Chrome
- #WCR3MAB Matte Black
- #WCR3R Raw Steel
- #WCR3SC Satin Chrome



# Heavy Duty Standards & Brackets

## Straight Arms & Waterfalls

### Heavy Duty Standards

Single Slotted  
Slots 1" long, 2" centers  
#W70048 4 feet long  
#W70060 5 feet long  
#W70072 6 feet long  
#W70084 7 feet long  
#W70096 8 feet long



### Rectangular Tubing Straight Arm

12" Long. To fit  
Heavy Duty Standards.  
#WRR12

## Shelf Brackets



### Heavy Duty Brackets

To fit #W700 Standards

#WG10 10" long  
#WG12 12" long  
#WG14 14" long  
#WG16 16" long



### Square Tubing Waterfall

To fit Heavy Duty Standards.  
#WTR7B



### Rectangular Tubing Waterfall

To fit Heavy Duty Standards.  
#WRR7B

### Shelf Rests

to fit #WG10, #WG12, #WG14, #WG16



Center Rest  
#WGLKC



Front Rest  
#WGLKF



Left Rest  
#WGLKL



Right Rest  
#WGLKR



Rubber Bumper  
#WBU

## Hangrail Brackets & Attachments



#WDL2

#WDR2

### Hangrail Attachments

Left and right attachments to fit  
#WG brackets. For 1 1/4" tubing.

#WDL2 Left Bracket

#WDR2 Right Bracket



### Hangrail Attachment

Center attachment to fit  
#WG brackets.

#WDC1 fits 1 1/16" tubing

#WDC2 fits 1 1/4" tubing



### 3" Bracket

To hold 1/2 x 1 1/2"  
Rectangular Tubing.  
Fits Heavy Duty Standards.

#WGR3 Chrome

#WGR3MAB Matte Black

#WGR3R Raw Steel



### 12" Bracket

To hold 1/2 x 1 1/2"  
Rectangular Tubing.  
Fits Heavy Duty Standards.

#WGR12 Chrome

#WGR12MAB Matte Black

#WGR12R Raw Steel

## Concealed Standards

For new construction or remodeling. Receives Heavy  
Duty Brackets. 8' Standard for 5/8" wallboard

### Item #

#W1000LX8



# Double Standards & Wall Mounted Hardware

## Wall Mounted Hardware

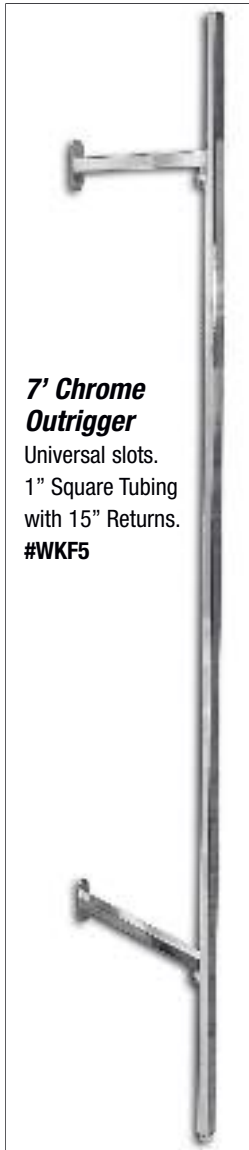

### 7' Chrome Outrigger

Universal slots.  
1" Square Tubing  
with 15" Returns.  
#WKF5



**5 Ball Waterfall**  
Wall Mount.  
#WTB5B



**Wall Hook**  
3" Long  
#WH3



**12" Straight Arm**  
Wall Mount.  
#WTB12



**7 Ball Waterfall**  
Wall Mount.  
#WTB7B

### Dressing Room Hook

5" Long  
#WH1



### Dressing Room Hook

10" Long  
#WH2



### 3/16" Toggle Bolt.

Use to mount most  
wall fixtures to  
drywall & plaster walls.  
#W3163

## Double Slotted Standards & Brackets



### Double Slotted Wall Standards

with 1/2" slots 1" centers

- #WSS2048 4 feet
- #WSS2060 5 feet
- #WSS2072 6 feet
- #WSS2084 7 feet
- #WSS2096 8 feet

### 12" Double Slotted Hangrail Bracket

- #WB112 for 1 1/16" tubing
- #WB212 for 1 1/4" tubing





# Rectangular & Round Tubing

## Rectangular Tubing & Accessories



### 1/2" x 1/2" Rectangular Tubing

#WRT2B	Matte Black	2' Long
#WRT4B	Matte Black	4' Long
#WRT4	Chrome	4' Long
#WRT4R	Raw Steel	4' Long
#WRT4SC	Satin Chrome	4' Long
#WRT5	Chrome	5' Long
#WRT6	Chrome	6' Long
#WRT8	Chrome	8' Long
#WRT12	Chrome	12' Long 

### Hooks

To fit 1/2" x 1/2"  
Rectangular Tubing

#WH4	4"
#WH6	6"
#WH9	9"
#WH12	12"



### 5 Hook Waterfall

To fit Rectangular tubing

#WRH5H Chrome



### End Knob

To fit Rectangular tubing

#WRK103	Chrome
#WRK103MAB	Matte Black



### 7 Cube Waterfall

To fit Rectangular tubing

#WRH7B	Chrome
#WRH7BR	Raw Steel
#WRH7BSC	Satin Chrome
#WRH7BMAB	Matte Black



### Extension End Knob

With 1" Extension Tube  
to fit Rectangular Tubing

#WRKEXT	Chrome
#WRKEXTMAB	Matte Black
#WRKEXTR	Raw Steel
#WRKEXTSC	Satin Chrome

### Rectangular Tubing Splicer

Use to join two lengths  
of tubing.

#WRESP



### 12" Straight Arm

To fit Rectangular tubing

#WRH12	Chrome
#WRH12MAB	Matte Black
#WRH12R	Raw Steel
#WRH12SC	Satin Chrome



## Round Tubing & Accessories

### 1/4" Tubing Splicer

Use to join two lengths  
of tubing.

#WRYS



### End Knobs

#WEK1	1/16" tubing
#WEK2	1/4" tubing



### 1/16" Chrome tubing

#WHR14	4 feet
#WHR15	5 feet
#WHR16	6 feet
#WHR18	8 feet
#WHR112	12 feet 

### 1/4" Chrome tubing

#WHR24	4 feet
#WHR25	5 feet
#WHR26	6 feet
#WHR28	8 feet
#WHR212	12 feet 



#WFLF1

#WFLH1

### Round Tubing Wall Flanges

#WFLF1	full round fits 1/16" tubing
#WFLH1	1/2 round fits 1/16" tubing
#WFLF2	full round fits 1/4" tubing
#WFLH2	1/2 round fits 1/4" tubing



#WFLF2



#WFLH2

# Glass Units

These units are shown with a component list of the individual item #'s needed. Bases are stocked items. Additional colors are available with a lead time of 2 weeks. Assembly required.



## #LGLASS3

Item#	Qty
#L1214	24
#L1224	4
#L1424	8
#L14QR	16
#LCON3C	14
#LCON4C	34
#JDC/54300VB	1



## #LGLASS2

Item#	Qty
#L1414	30
#L1214	44
#LCON2C	16
#LCON3C	68
#LCON4C	42
#JDC/6030M	1

## GLASS UNIT BASES

#JDC/30R	30" Dia. Round Revolving Base
#JDC/54300V	54"W x 30"D x 6"H Oval Base
#JDC/4830	48"W x 30"D x 6" H Rectangular Base
#JDC/6030	60"W x 30"D x 6" H Rectangular Base
#JDC/7016	70"W x 16"D x 6" H Rectangular Base
Available in Black & Maple	
#JDC/1812	18"W x 18"D x 12" H Square Base
Available in Black, Maple, White & Cherry	

 Glass items with a dimension greater than 16" must be shipped via common carrier. Glass items shipped require special packaging and a \$8.00 fee per shipping carton will be automatically added to your order.



## #LGLASS1

Item#	Qty
#L1616	5
#L1648	4
#LHINGEC	2
#LHASPC	1
#LCON2C	12
#LMS3	12
#JDC/1812M	1



## #LGLASS6

Item#	Qty
#L1216	49
#LCON2C	8
#LCON3C	28
#LCON4C	24
#JDC/7016M	1



## #LGLASS4

Item#	Qty
#L14QR	16
#L1414	16
#LCON3C	8
#LCON4C	32
#JDC/30RM	1

# Tempered Glass



#LCON2

#LCON3

#LCON4

#LMS3

#LMS4



#LHASP

#LHINGE

#LCON2120

#LCON3120

## Chrome Connecting Hardware

Item #	Description
#LCON2	2 Way Connector
#LCON3	3 Way Connector
#LCON4	4 Way Connector
#LMS3	3 Way Inside Shelf Connector
#LMS4	4 Way Inside Shelf Connector
#LHINGE	Door Hinge
#LHASP	Door Hasp Pair
#LCON2120	2 Way 120 Degrees
#LCON3120	3 Way 120 Degrees

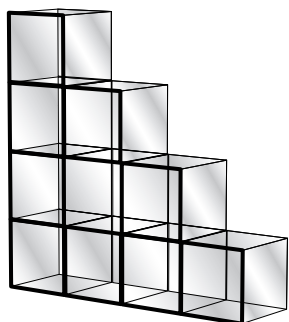

#DM6

Glass sizes which can be used for this configuration

12" X 12"  
14" X 14"  
16" X 16"  
20" X 20"

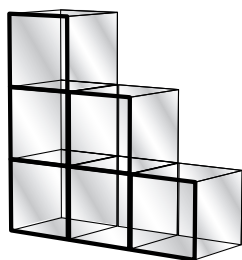

#DM5

Glass sizes which can be used for this configuration

12" X 12"  
14" X 14"  
16" X 16"  
20" X 20"

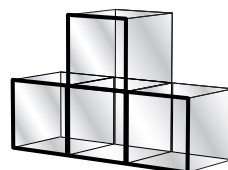

#DM2

Glass sizes which can be used for this configuration

12" X 12"  
14" X 14"  
16" X 16"

## 3/8" Annealed Clear Glass

Flat Polish

Item #	Size
#LTE1224	12" x 24"
#LTE1236	12" x 36"
#LTE1248	12" x 48"
#LTE1424	14" x 24"
#LTE1436	14" x 36"
#LTE1448	14" x 48"
#LTE1648	16" x 48"

## Full Round Glass

Pencil Polish

Item #	Size
#LR30	30" Diameter
#LR36	36" Diameter

## 3/16" Quarter Round Glass

Pencil Polish

Item #	Size
#L12QR	12" Radius
#L14QR	14" Radius
#L16QR	16" Radius
#L20QR	20" Radius

## 3/16" Tempered Binning Glass

Pencil Polish

Item #	Size
#L1010	10" x 10"
#L1012	10" x 12"
#L1014	10" x 14"
#L1016	10" x 16"
#L1212	12" x 12"
#L1214	12" x 14"
#L1216	12" x 16"
#L1414	14" x 12"
#L1616	16" x 16"
#L1818	18" x 18"
#L2020	20" x 20"

## 3/16" Tempered Shelf Glass

Pencil Polish

Item #	Size
#L844	8" x 44"
#L866	8" x 66"
#L1024	10" x 24"
#L1044	10" x 44"
#L1048	10" x 48"
#L1066	10" x 66"
#L1224	12" x 24"
#L1236	12" x 36"
#L1248	12" x 48"
#L1424	14" x 24"
#L1436	14" x 36"
#L1448	14" x 48"
#L1624	16" x 24"
#L1636	16" x 36"
#L1648	16" x 48"

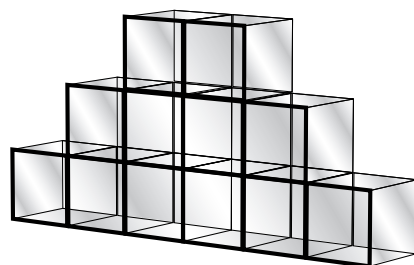

#DM4

Glass sizes which can be used for this configuration

12" X 12"  
14" X 14"  
16" X 16"  
20" X 20"

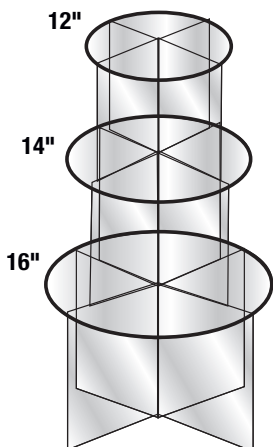

## Glass & Connectors

12", 14" & 16" Tiers  
#QS2

## Mini Binning Grid

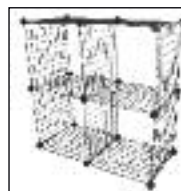

14" x 14"  
Black Binning Grid  
#G1515B

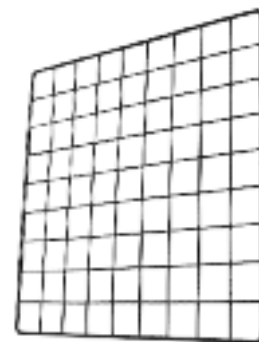

Black Plastic  
Grid Connectors  
#GCONNB

☛ Glass items with a dimension greater than 16" must be shipped via common carrier. Glass items shipped require special packaging and a \$8.00 fee per shipping carton will be automatically added to your order.

# Gondola Units

## Gondola Kit Units, Gondola Starter & Add-On Units

Preconfigured Units with Shelves. Wall Units include 4 Shelves + Base Deck, Aisle & End Cap Units include 3 Shelves + Base Deck, 36" or 48" Wide. Configure your own Units, begin each section with a Starter Unit, add as many "Add-On" Units as needed. Add Shelves & Accessories 36" or 48" Wide.

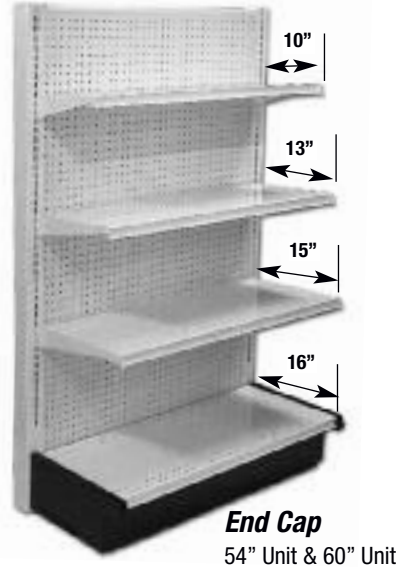
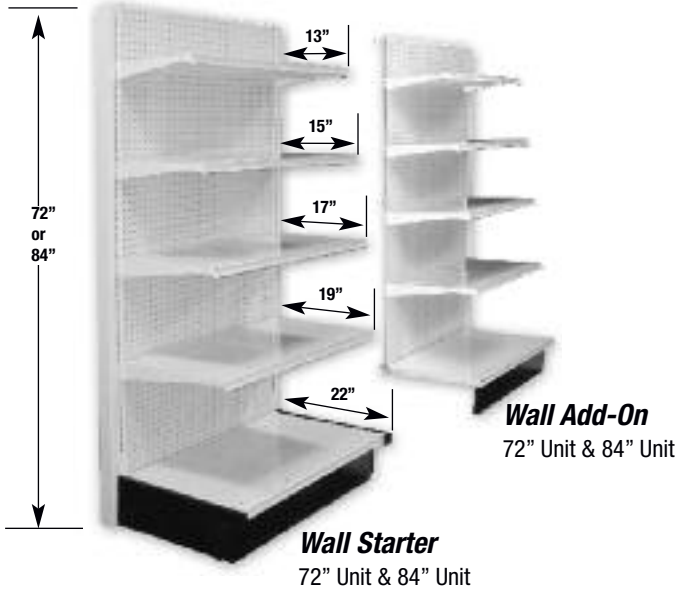

END CAP UNITS		
	ITEM #	BASE SIZE
54" HIGH	EC163654	13" x 36"
	EC134854	13" x 48"
	EC164854	16" x 48"
	EC194854	19" x 48"
	EC224854	22" x 48"
60" HIGH	EC163660	13" x 36"
	EC134860	13" x 48"
	EC164860	16" x 48"
	EC194860	19" x 48"
	EC224860	22" x 48"
72" HIGH	EC163672	13" x 36"
	EC134872	13" x 48"
	EC164872	16" x 48"
	EC194872	19" x 48"
	EC224872	22" x 48"

WALL STARTER UNITS		WALL ADD-ON UNITS		
	ITEM #	BASE SIZE	ITEM #	BASE SIZE
72" HIGH	WS163672	13" x 36"	WA163672	13" x 36"
	WS134872	13" x 48"	WA134872	13" x 48"
	WS164872	16" x 48"	WA164872	16" x 48"
	WS194872	19" x 48"	WA194872	19" x 48"
	WS224872	22" x 48"	WA224872	22" x 48"
84" HIGH	WS163684	13" x 36"	WA163684	13" x 36"
	WS134884	13" x 48"	WA134884	13" x 48"
	WS164884	16" x 48"	WA164884	16" x 48"
	WS194884	19" x 48"	WA194884	19" x 48"
	WS224884	22" x 48"	WA224884	22" x 48"
96" HIGH	WS163696	13" x 36"	WA163696	13" x 36"
	WS134896	13" x 48"	WA134896	13" x 48"
	WS164896	16" x 48"	WA164896	16" x 48"
	WS194896	19" x 48"	WA194896	19" x 48"
	WS224896	22" x 48"	WA224896	22" x 48"

AISLE STARTER UNITS		AISLE ADD-ON UNITS		
	ITEM #	BASE SIZE	ITEM #	BASE SIZE
54" HIGH	DS163654	13" x 36"	DSA163654	13" x 36"
	DS134854	13" x 48"	DSA134854	13" x 48"
	DS164854	16" x 48"	DSA164854	16" x 48"
	DS194854	19" x 48"	DSA194854	19" x 48"
	DS224854	22" x 48"	DSA224854	22" x 48"
60" HIGH	DS163660	13" x 36"	DSA163660	13" x 36"
	DS134860	13" x 48"	DSA134860	13" x 48"
	DS164860	16" x 48"	DSA164860	16" x 48"
	DS194860	19" x 48"	DSA194860	19" x 48"
	DS224860	22" x 48"	DSA224860	22" x 48"
72" HIGH	DS163672	13" x 36"	DSA163672	13" x 36"
	DS134872	13" x 48"	DSA134872	13" x 48"
	DS164872	16" x 48"	DSA164872	16" x 48"
	DS194872	19" x 48"	DSA194872	19" x 48"
	DS224872	22" x 48"	DSA224872	22" x 48"

Slatwall Rails	
ITEM #	Description
K/CR4-SW	48" W Center Slatwall Rail
K/LR4-SW	48" W Lower Slatwall Rail

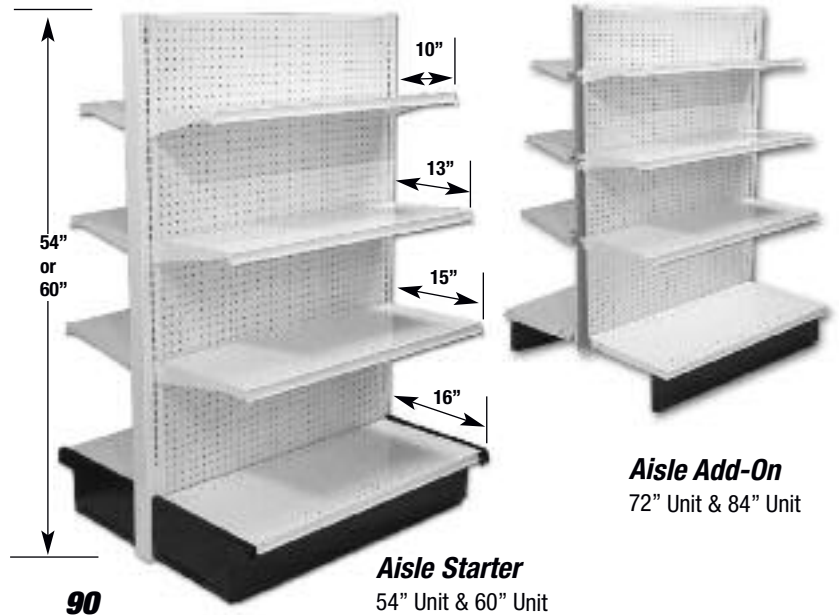

# Gondola Components

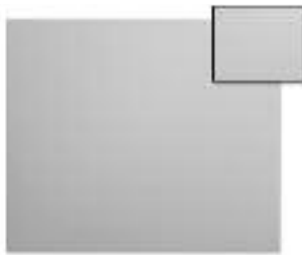
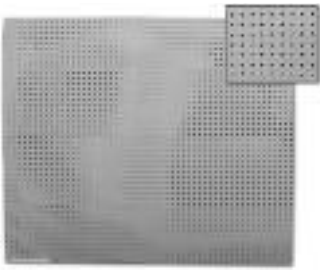

## Peg Board

	ITEM #	SIZE
36" WIDE	K/ZBP348	36" x 48"
	K/ZBP354	36" x 54"
	K/ZBP360	36" x 60"
	K/ZBP372	36" x 72"
	K/ZBP384	36" x 84"
	K/ZBP396	36" x 96"
48" WIDE	K/ZBP448	48" x 48"
	K/ZBP454	48" x 54"
	K/ZBP460	48" x 60"
	K/ZBP472	48" x 72"
	K/ZBP484	48" x 84"
	K/ZBP496	48" x 96"

## Plain Board

	ITEM #	SIZE
36" WIDE	K/ZBM348	36" x 48"
	K/ZBM354	36" x 54"
	K/ZBM360	36" x 60"
	K/ZBM372	36" x 72"
	K/ZBM384	36" x 84"
	K/ZBM396	36" x 96"
48" WIDE	K/ZBM448	48" x 48"
	K/ZBM454	48" x 54"
	K/ZBM460	48" x 60"
	K/ZBM472	48" x 72"
	K/ZBM484	48" x 84"
	K/ZBM496	48" x 96"

## Pegboard Hooks

Price per Hook (ea)		
Item #	Length	Gauge
P2002	2" L	1/8" Thick
P2004	4" L	1/8" Thick
P2006	6" L	1/8" Thick
P2008	8" L	1/8" Thick
P20010	10" L	1/8" Thick
P1814	4" L	1/4" Thick
P1816	6" L	1/4" Thick
P1818	8" L	1/4" Thick
P18110	10" L	1/4" Thick
P18112	12" L	1/4" Thick

## Bottom Base Bracket

ITEM #	Description
K/BBS13-06	6" x 13" Base Bracket
K/BBS16-06	6" x 16" Base Bracket
K/BBS19-06	6" x 19" Base Bracket
K/BBS22-06	6" x 22" Base Bracket



## Front Kick Plate

ITEM #	Description
K/FKP-3-06	6" x 36" Front Kick Plate
K/FKP-4-06	6" x 48" Front Kick Plate

## Bottom Base Bracket Cover (2PK)

ITEM #	Description
K/BBS-C13-06	6" x 13" Base Bracket Cover
K/BBS-C16-06	6" x 16" Base Bracket Cover
K/BBS-C19-06	6" x 19" Base Bracket Cover
K/BBS-C22-06	6" x 22" Base Bracket Cover



## Lower Rails

ITEM #	Description
K/LR3	36" L Lower Rail
K/LR4	48" L Lower Rail



## Shelves

	ITEM #	SIZE
36" WIDE	K/US310	10" x 36"
	K/US313	13" x 36"
	K/US315	15" x 36"
	K/US316	16" x 36"
	K/US319	19" x 36"
48" WIDE	K/US410	10" x 36"
	K/US413	13" x 48"
	K/US415	15" x 48"
	K/US416	16" x 48"
	K/US419	19" x 48"
	K/US422	22" x 48"



## Top Rails

ITEM #	Description
K/TR3	36" L Top Rail
K/TR4	48" L Top Rail



## Base Deck

	ITEM #	SIZE
36" W	K/BD316	16" x 36"
	K/BD322	22" x 36"
48" W	K/BD413	13" x 48"
	K/BD416	16" x 48"
	K/BD419	19" x 48"
	K/BD422	22" x 48"



## Center Rails

ITEM #	Description
K/CR3	36" L Center Rail
K/CR4	48" L Center Rail



## Upright & Upright Cover

	ITEM #	SIZE
Upright	K/USRP54	54"
	K/USRP60	60"
	K/USRP72	72"
	K/USRP84	84"
	K/USRP96	96"
Upright Cover	K/USRP-C54	54"
	K/USRP-C60	60"
	K/USRP-C72	72"
	K/USRP-C84	84"
	K/USRP-C96	96"

# Aaron Contemporary Raw Steel Fixtures

## Racks & Arm Inserts

Racks shown are available with your choice of arm inserts. Please be sure to indicate which finial you would like as an accent on the insert chosen. Wherever finials and inserts are shown, they are included in the price of the base. Additional arm inserts and finials can be ordered separately to allow you to interchange your displays.

12" Straight Arm Insert  
#RM/INS106V



12" 6 notch  
Waterfall Insert  
#RM/INS107V



12" x 25" Bow Arm Insert  
#RM/INS108V



#RM/MC57  
5 1/2" x 7"  
Card Frame w/stem



12" Straight Arm ADD-ON  
with Clamp  
#RM/TV12



2 Way Base  
and Inserts  
#RM/TS102V



3 Way Base and Inserts  
#RM/TW101V



4 Way Base  
and Inserts  
#RM/FW101V



One Way Base Including  
Choice of Insert  
#RM/OW101V

### Insert Options



Peg Hook Insert  
(With choice of Finial)  
#RM/INS110V



2 Way Base and Inserts  
with Locking Casters  
Included  
#RM/TSWH100V



### Rolling Racks

adjustable from 56" to 71" High

30" Rolling Rack. Finial Included  
Please specify  
#RM/RR30V

36" Rolling Rack. Finial Included  
Please specify  
#RM/RR36V

48" Rolling Rack. Finial Included  
Please specify  
#RM/RR48V



Rolling Rack Add-On Arm for  
48" Rolling Rack  
#RM/RR48AO

MCC4LOCK- locking casters included with  
rolling rack

## Showcases



**Jewelry Case**  
4 Glass Shelf  
Showcase w/Lock  
16" x 16" x 72"  
#RM/SC1672V



### Jewelry Cases

With drop down back door & lock.  
36" Overall Height

- #RM/JC202V 12"H x 17"W x 28"L Case
- #RM/JC203V 12"H x 17"W x 36"L Case
- #RM/JC204V 12"H x 17"W x 48"L Case



### Ledgetop Counter

43" H x 20" x 48" L  
Raw Steel Frame  
with Maple top and Sides,  
and removeable shelf  
#RM/LT4V



### Double Sided Shelving Unit

with Maple shelves  
72"L x 31"W x 54"H  
#RM/DSS-W

# Aaron Contemporary™ Raw Steel Fixtures

## Table Displays



### **Nestable Knockdown Tables**

Includes Maple Melamine Top.



- #RM/TD601V 24"W x 40" L x 28" H
- #RM/TD602V 24"W x 48" L x 31" H
- #RM/TD603V 36"W x 56" L x 34" H



### **Nesting Tables**

With Maple Melamine Top.

Tables can be nested together or used separately.

- #RM/TD501 24" W x 42" L x 28" H 
- #RM/TD502 24" W x 48" L x 30" H 



### **Display Table**

18" W x 48" L x 32" H

With Maple Melamine Top.

#RM/TD1848 



### **Round Table**

with Glass Top

30"H x 36"Diameter

#RM/RT36 



### **Decorative Glass Top Table**

17" W x 24" L x 24" H

#RM/TD105



# Wall Mounted Hardware



This Wall Unit consists of the following:  
 2 ea. #RM/DWB101  
 2 ea. #RM/HBBRKT  
 1 ea. #RM/HB4

## 6" Wall Mount Hook

(Hardware not included.)  
 #RM/WH6



## 3" Wall Bracket

for 4' or 8'  
 Hangrail  
 (Hardware not included.)  
 #RM/SWB3



## Decorative Wall Mount

to Accommodate Inserts  
 in this Grouping  
 (Hardware not included.)  
 #RM/DWB101



## 3" x 6" Wall Mount

to Accommodate Inserts  
 in this Grouping  
 (Hardware not included.)  
 #RM/DWB202



Raw Steel Hangrail with End Caps.  
 For use with Hangrail Brackets

- #RM/HB4 4' Hangrail
- #RM/HB8\* 8' Hangrail
- #RM/END 1 3/4" Dia. End Cap

*\*(Requires a minimum of 3 RM/DWB101 and RM/HBBRKT for additional support)*

## 12" Straight Arm Wall Bracket

Bracket for 4' or 8' Hangrail  
 (Hardware not included.)  
 #RM/SWB12



## 12" Straight Arm Wall Insert

#RM/WALLARM 1



## Waterfall Arm Wall Insert

#RM/WALLARM 2



## 12" Slant Hangrail Bracket

#RM/HBBRKT



## Wall Mounted Bracket

to Hold Shelf  
 (Hardware not included.)  
 #RM/SBRKT12

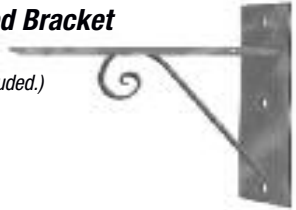

## Wall Mount Hangrail

48" Wide  
 (Hardware not included.)  
 #RM/HB48



## 3 Hat Display

26" Wall Mounted  
 (Hardware not included.)  
 #RM/3HAT

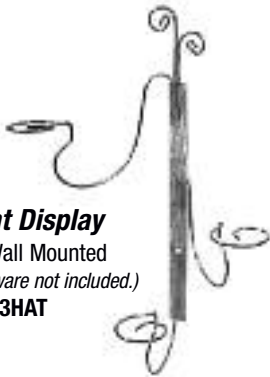

## 6 Hat Displayer

47" Wall Mounted  
 Vertical  
 (Hardware not included.)  
 #RM/WVHAT



## 6 Hat Displayer

47" Wall Mounted Horizontal  
 (Hardware not included.)  
 #RM/WHHAT



## Straight Arm

For Rail and Shelf  
 #RM/HBBRKT2

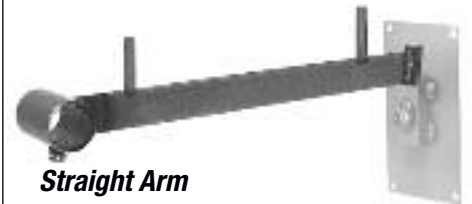

## 6" Wall Arm Faceout

#RM/WALLARM4

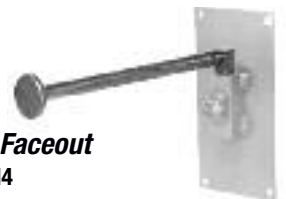

# Aaron Contemporary™ Raw Steel Fixtures

## Outriggers

### 90" Outrigger

Made of 1" Square Tubing with 14½" returns. Designed to accommodate a maximum 14" deep shelf.

Choice of Finials  
#RM/URP90

### 96" Outrigger

Made of 1" Square Tubing with 14½" Returns. Designed to accommodate a maximum 14" deep shelf.

Choice of Finials  
#RM/URP96

### 96" Heavy Outrigger

Made of 2" Square Tubing with 15" returns with universal slotting. Hardware not included.

#HL/URP96R 

### 7 Cube Waterfall

To fit Rectangular Tubing  
#WRH7BR

### 12" Straight Arm

To fit Rectangular Tubing  
#WRH12R

### 12" Bracket

to hold ½" x 1½" Rectangular Tubing. Fits Universal Standards with ½" slots, 1" centers.

#WCR12R

### End Cap

1¾" Dia.

#RM/END

(See page 95 for price)

### Hangrail Tubing

4' Long

#RM/HB4

8' Long

#RM/HB8

(See page 95 for price)

### Hangrail Bracket

to hold 1¼" Diameter Tubing. Fits Universal Standards with ½" slots, 1" centers.

#W8537AR

### 14" Shelf Bracket

Bracket to hold wood shelf

#RM/W8114

### 3" Rectangular Tubing Bracket

3" Bracket to hold ½" x 1½" Rectangular Tubing. Fits Universal Standards with ½" slots & 1" centers.

#WCR3R

### Rectangular Tubing

4' Long

#WRT4R

### 12" Straight Arm

To fit Rectangular Tubing  
#WRH12R

### Rectangular Tubing

4' Long

#WRT4R

### 3" Rectangular Tubing Bracket

3" Bracket to hold ½" x 1½" Rectangular Tubing. Fits Universal Standards with ½" slots & 1" centers.

#WCR3R

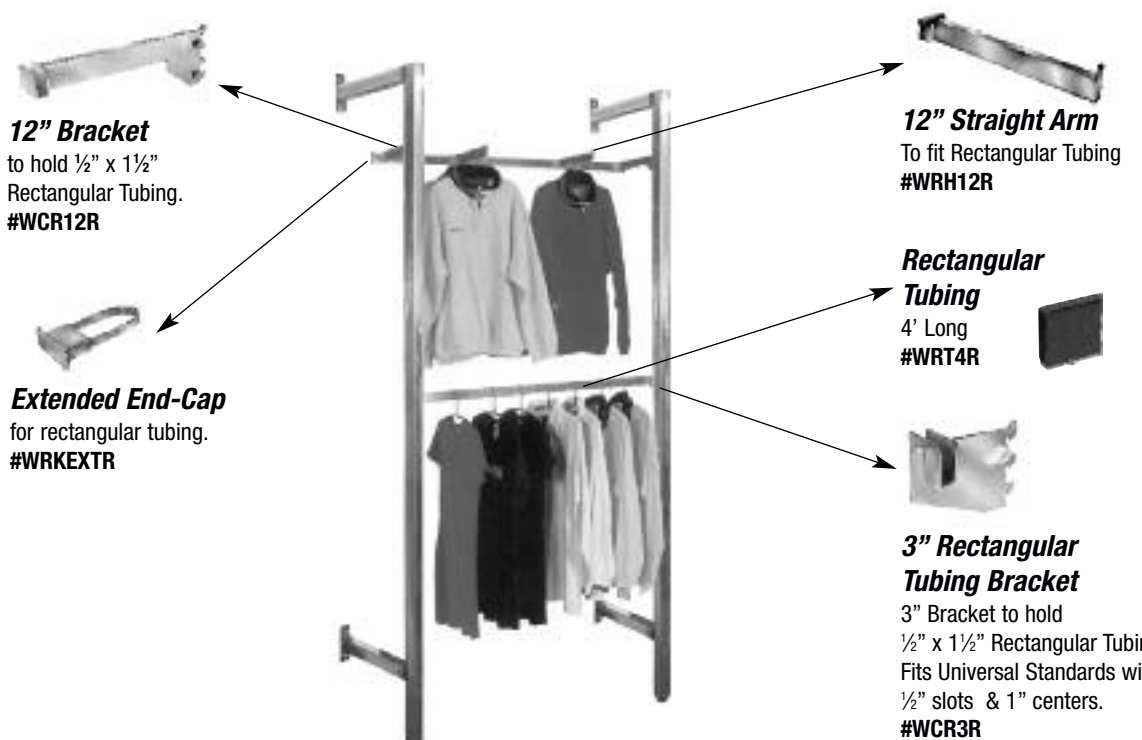
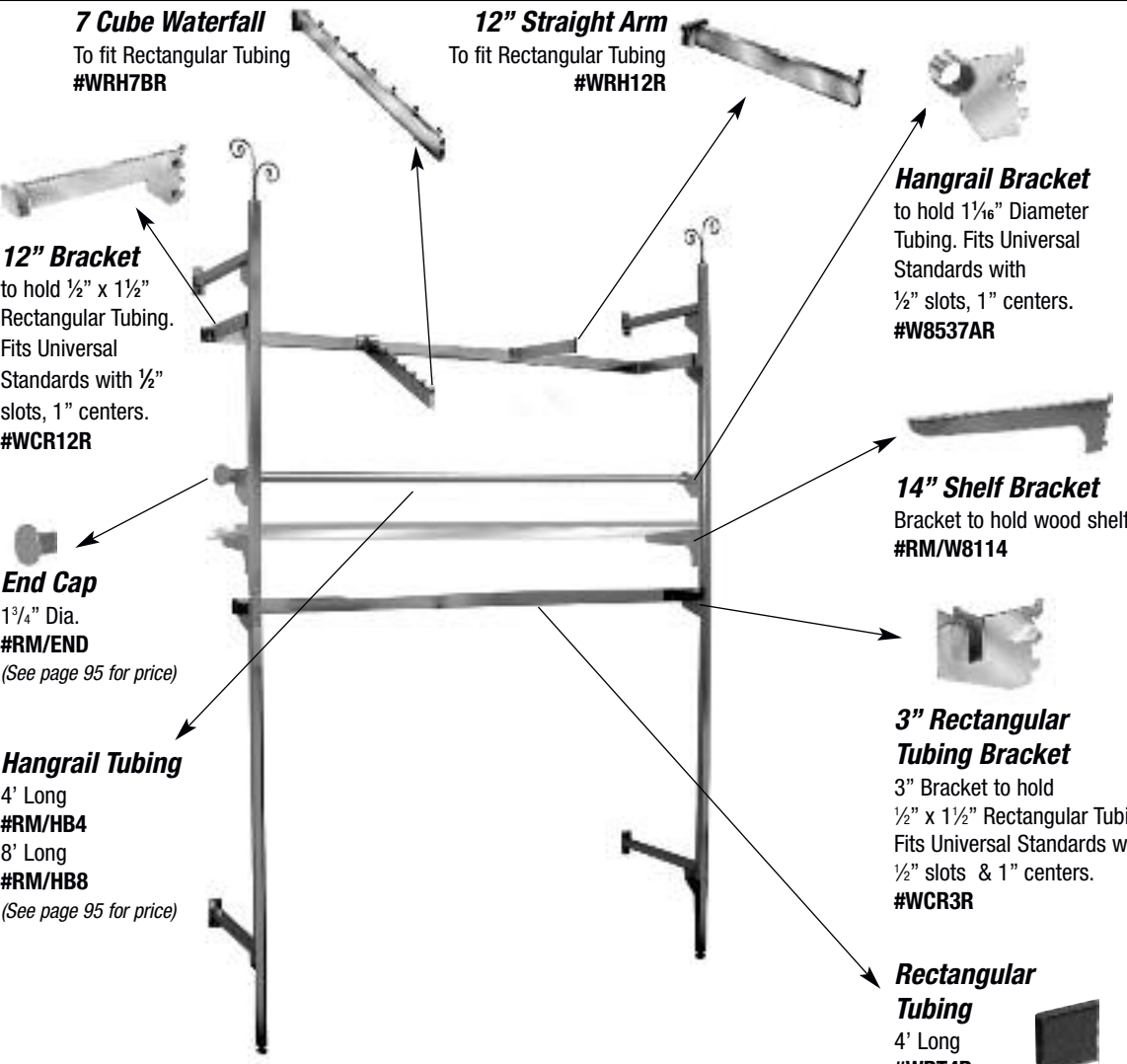

## Merchandisers



### Scarf and Belt Display

60" W x 63" H

(Belt Component sold separately)

#RM/SBD101



### Ladder Unit

20" W x 60" H

#RM/LD102

### Ladder Accessories

#### Perforated Metal Shelf

17" W x 9" D

#RM/LDSHELF



#### Display Hooks

#RM/LDH4 4"

#RM/LDH6 6"

#RM/LDH9 9"



## Mirrors



### Oval Floor Mirror

Single sided.

28" W x 58" H

#RM/FM100

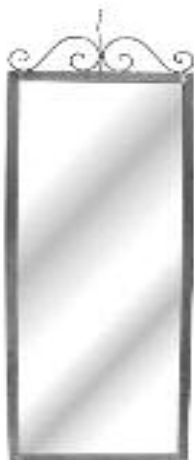

### Hanging Wall Mirror

24" x 60",

with Wall Mounts

#RM/HWM101



### Three Way Mirror

Center Mirror 30" W x 60" H.

Side Mirrors 24" W x 60" H.

Overall Height 84"

#RM/TWM101

### Counter Mirror

Single sided.

16" W x 24" H

#RM/CM100



### Counter Mirror

Single sided.

5" W x 15" H

#RM/CM200



### Shoe Mirror

Double sided.

16" W x 18" H

#RM/SM101



# Aaron Contemporary™ Raw Steel Fixtures

## Jewelry Displays



**Jewelry Display**

3 Tier  
15" High  
#RM/JDB20



**Earring Card Display**

10"W x 6"D x 15"H  
#RM/JDE1



**Spinner Earring Card Display**

10"W x 6"D x 15"H  
#RM/JDE2



**Two Tier Watch Display**

9 1/4"H x 10 1/4"W  
#RM/JDW101



**Earring Display**

T-Type  
5 1/2" High  
#RM/JDE74



**24 Pair Earring Display**

15" High  
#RM/JDE116



**Jewelry & Keychain Display**

16" High  
#RM/JDM3



**Necklace Display**

Adjusts from 13"-21"H  
11"W x 6"D  
#RM/JDN101



**6 Pair Earring Display**

7" High  
#RM/JDE6



**Sign Holders**

5 1/2" x 7" Double Sided  
#RM/MC57CT



**Set of 3 Cubes**

4"H x 6"W x 6"L  
6"H x 6"W x 8"L  
8"H x 6"W x 10"L  
#RM/CS381

**2 Tier Jewelry Display**

12" High  
#RM/JD2T



**Jewelry Stand**

15" High  
#RM/JD115ARD



**Jewelry Displayer**

10" High  
#RM/JD110



**Jewelry Displayer**

16" High  
#RM/JD116



# Shoe & Hat Displayers



**Double Shoe Stand**  
8" High  
#RM/SS308D



**Single Shoe Stand**  
8" High  
#RM/SS308S



**Single Shoe Display**  
6" High  
#RM/SS206S



**Double Shoe Stand**  
24" High  
#RM/SS324D



**Hat Stands**  
10" H  
#RM/HS110  
16" H  
#RM/HS116

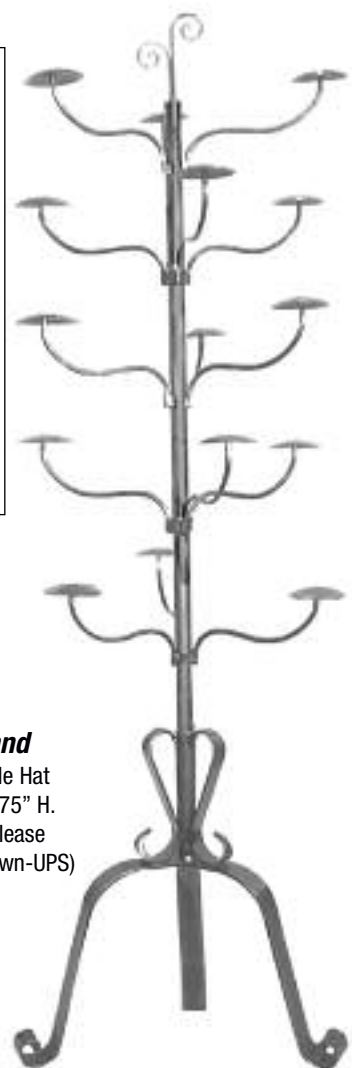
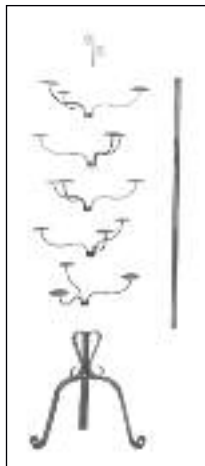

**Floor Hat Stand**  
with 15 Adjustable Hat Holders 24" W x 75" H. Finial Included. Please specify (knockdown-UPS)  
#RM/HSF15V

# Aaron Contemporary™ Raw Steel Fixtures

Aaron Contemporary™ has created a new and unique line of retail store fixtures as an alternative to the traditional chrome fixture. The fixtures of Aaron Contemporary™ are manufactured from raw steel which are cut, welded (weld marks are part of the look), bent, fabricated and then given a protective clear coat, to create functional fixtures while maintaining that natural look of gun metal gray. Aaron Contemporary™ fixtures allow you the appearance of a custom look at an affordable price.

## Finials and Neckblocks

Adult Neckblock  
with choice of finial.

#RM/NBF Natural  
#RM/NBF-B Black



#FO/MR5  
Flat Neckblock Only  
Natural or Black



#RM/NBF with  
#RM/F1  
Finial, 6¼"



#RM/NBF with  
#RM/F2  
Finial, 5"



#RM/NBF with  
#RM/F3  
Finial, 6¼"



#RM/NBF with  
#RM/F4  
Finial, 4"



#RM/NBF with  
#RM/F5  
Finial, 2½"



#RM/NBF with  
#RM/F6  
Finial, 3"



#RM/NBF with  
#RM/F7  
Finial, 3 ½"



#RM/NBF with  
#RM/F8  
Finial, 2 ¾"

## Forms & Bases

These decorative long stem bases accommodate men's and ladies' forms. Forms may be ordered in either Black or Natural colors. Complete the look by ordering coordinating neckblocks with matching finials. Bases can be cut to accommodate blouse and children's forms.



Ladies' Medium  
Dress Form  
Natural or Black  
#FO/JF6



Men's Medium Size  
Coat Form  
Natural or Black  
#FO/GH6



Women's Medium Size  
Pant Form  
Natural  
#FO/BV267N



Base for Form  
with Long 7/8" Stem  
#RM/MB2L



Base for Form  
with Long 7/8" Stem  
#RM/MB5L



Base for Form  
with Long 7/8" Stem  
#RM/MB6L



Base for Form  
with Long 7/8" Stem  
#RM/MB10L



Base for Form  
with Long 7/8" Stem  
#RM/MB12



Base for Children's Form  
with Long 7/8" Stem  
#RM/MB12-K

Items shown are FedEx Ground shippable unless otherwise noted.

## Merchandisers



**Spiral Rack**  
with choice of finial  
23" W x 74" H  
#RM/SC102V



**Two Tier  
Revolving Belt Rack**  
with choice of finial  
69" High  
Upper Tier 19" Dia.  
Lower Tier 29" Dia.  
#RM/RBR3V



**Multi-Level  
Adjustable Unit**  
with Perforated Shelves  
with choice of finial  
21" W x 74" H  
#RM/MLSU5V

## Purse & Blouse Displayers



**Purse Displayer**  
26" W x 32" H  
#RM/PD101



**Hook Stand**  
Adjustable  
Counter Top  
26" to 36" H  
#RM/ADJ2

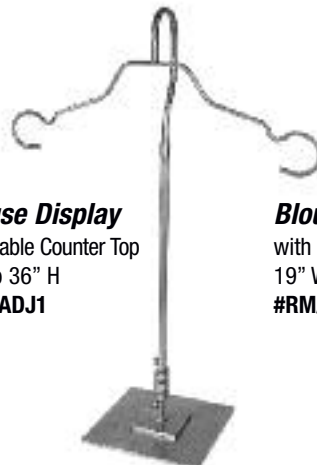

**Blouse Display**  
Adjustable Counter Top  
26" to 36" H  
#RM/ADJ1



**Blouse Displayer**  
with Scroll Top  
19" W x 30" H  
#RM/BD101

# Molded Forms

## Women's Vaccum Molded Forms



**Junior Form 5-9**  
Available in Black, White & Clear  
#FVM/8



**Ladies Swimwear Form**  
Available in Clear Only  
#FVM/2CLR



**Ladies Swimwear w/Swivel Hook**  
Available in Black, White & Clear  
#FVM/22



**Ladies Swimwear w/Swivel Hook**  
Available in Black, White & Clear  
#FVM/28



**Female T-Shirt Form**  
Available in Black Only  
#FVM/54BLK



**Stand Up T-Shirt Form**  
Available in Black Only  
#FVM/86BLK

## Women's Injection Molded Forms



**Ladies Blouse Form**  
Available in Black, White & Silver  
#FLHR14



**Ladies Blouse Form**  
Available in Black, White, Clear  
& Silver  
#FLHR15



---

---

## Men's and Children's Vaccum Molded Forms



**Small Male T-Shirt Form**

Available in Black Only  
#FVM/42



**Medium Male Torso w/Swivel Hook**

Available in Black & White  
#FVM/66



**Medium Male Shirt Form**

Available in Black & White  
#FVM/84

## Men's Injection Molded Forms

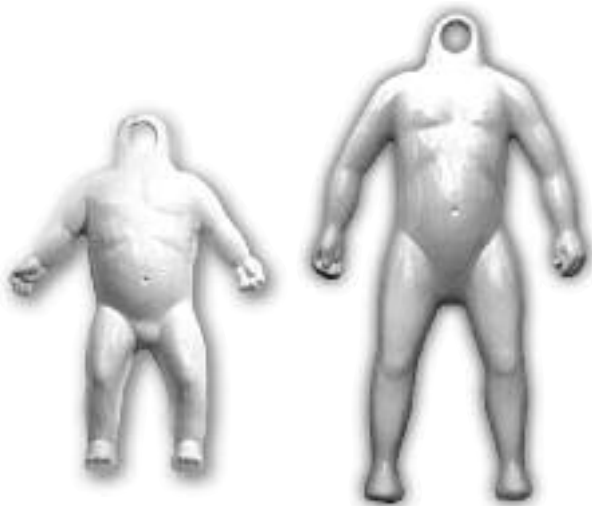

**Kid's Size 2T Full Body**

Available in White Only  
#FVM/52WHT

**Kid's Size 4T Full Body**

Available in White Only  
#FVM/62WHT



**Men's Shirt Form**

Available in Black, White & Silver  
#FLHR17



**Men's Body Form**

Available in Black, White & Silver  
#FLHR16

# Display Forms

## Torso Forms



**Female Torso Form**  
fiberglass form  
#FTF/TF20 Fleshtone  
#FTF/TF20S Silver



**Male Torso Form**  
fiberglass form  
#FTF/TM80 Fleshtone  
#FTF/TM80S Silver



**Clear Female Torso Form**  
Plastic form  
Includes 7/8" flange  
#FJW324



**Plastic Female Torso Form**  
Fleshtone  
#FTF/PTL10



## Brazilian Style Forms



**Plastic Pant Form**  
Brazilian Style  
#FTF/FBBF1

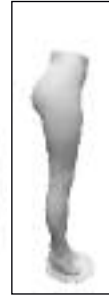

**Plastic Full Body Form**  
Brazilian Style  
#FTF/FBBF2

## Underwear Forms



**Male Underwear Form**  
fiberglass form  
#FLO/UM15MB Matte Black  
#FLO/UM15MW Matte White



**Female Underwear Form**  
fiberglass form  
#FLO/UF10MB Matte Black  
#FLO/UF10MW Matte White



**Vinyl Glove Hands - Fleshtone**  
#CG7/L 12" Ladie's Left Glove Hand  
#CG4/L 12" Ladie's Right Glove Hand  
#CG4/R 12" Men's Left Glove Hand  
#CG7/L 12" Men's Right Glove Hand



**Clear Plastic Bra Form on Base**  
#F/JC417



**Clear Plastic hanging Bra Form**  
#F/JC517

## Low Cost Fiberglass Mannequin Legs



#FTF/LEG1FWHT



#FTF/LEG2FWHT



#FTF/LEG3FWHT  
(base not included)



#FTF/LEG5MWH



#FTF/LEG8MWH

# Dressmaker Forms

With Collapsible Shoulders



**Dressmaker Form**  
Natural Linen  
with Black Basket & Base  
#FLO/DF4 Size 4



**Dressmaker Form**  
Natural Linen  
with Black Basket & Base  
#FLO/DF6 Size 6



**Dressmaker Form**  
Natural Linen  
with Black Basket & Base  
#FLO/DF8 Size 8



**Dressmaker Form**  
Natural Linen  
with Black Basket & Base  
#FLO/DF10 Size 10



**Dressmaker Form**  
Natural Linen  
with Black Basket & Base  
#FLO/DF12 Size 12

## Hanging & Display Forms

**Ladies Torso**  
form with flange.  
#FO/HF1



#RM/MB12

**Men's Torso form**  
with flange.  
#FO/HM1



#RM/MB12

**Notched Adjustable Costumer**  
Brushed Metal Hanging Base  
Adjusts from 49"-83"  
#FMB4

**Flat Base**  
12" x 16" offset  
base with Long  
7/8" Stem  
#RM/MB12

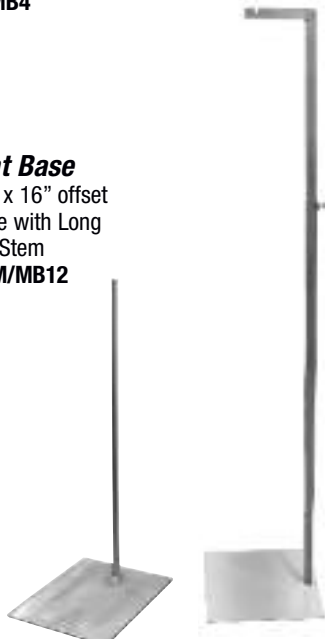

### "Dressmaker" Style Display Form

**Acorn Cap Neckblock**  
Chrome or Black  
#FO/NB351CHR  
#FO/NB351BK

**Dressmaker Style  
Display Form**  
Natural with Chrome  
or Black Basket  
#FO/DMF30CH  
#FO/DMF30BK

**Dressmaker Style  
Display Base**  
7/8" Upright  
#FDMB1 Chrome  
#FDMB2 Black



**Dressmaker Style  
Display Base**  
7/8" Upright  
#FDMB3 Raw Steel



# Economy Jersey Covered Forms

**Fairmont Neckblock**  
#FOPNB1



**Coat Form**  
French Style  
Coat Form  
Size 99mm  
#FOP85CR

**Somerset Tripod**  
#FOSM1

**Sussex Neckblock**  
#FOPNB3



**Flat Shirt Form**  
Men's Classic Flat  
Front Shirt Form  
Size 113mm  
#FOP93WH

**Barclay Round**  
#FOBR1

**Cheshire Neckblock**  
#FOPNB2



**Muscular  
Shirt Form**  
Classic Style  
Muscular Shirt Form  
Size 113mm  
#FOP91CR

**Squared Base**  
#FOD/SQF5

**Fairmont Neckblock**  
#FOPNB1



**Shirt Form**  
French Style  
Shirt Form  
Size 99mm  
#FOP98CR

**Barclay Round**  
#FOBR2

**Fairmont Neckblock**  
#FOPNB1



**Blouse Form**  
French Style  
Blouse Form  
Size 99mm  
#FOP34CR

**Barclay Round**  
#FOBR2

**Cheshire Neckblock**  
#FOPNB2



**Dress Form**  
Classic Style  
Dress Form  
Size 113mm  
#FOP22CR

**Cambridge Tripod**  
#FOCB1

**Fairmont Neckblock**  
#FOPNB1



**Dress Form**  
French Style  
Dress Form  
Size 99mm  
#FOP26CR

**Round Base**  
#FOD/RNDF5

**Sussex Neckblock**  
#FOPNB3



**Blouse Form**  
Classic Style  
Blouse Form  
Size 113mm  
#FOP33CR

**Round Base**  
#FOD/RNDC1

# French Design Forms



## Child's Form

10 - 12 yrs old  
Natural  
#FO/JE7N  
#FO/MC4 Neckblock  
#FO/PR5N Base



## Child's Form

6 - 8 yrs old  
Natural  
#FO/JE5N  
#FO/MC4 Neckblock  
#FO/PR5N Base



## Child's Form

3 - 4 yrs old  
Natural  
#FO/JE4N  
#FO/MC1 Neckblock  
#FO/PR5N Base.



## Child's Form

6 Months  
Natural  
#FO/JE2N  
#FO/MC1 Neckblock  
#FO/PR5N Base.



## Men's Medium Coat Form

Natural  
#FO/GH6N  
#RM/NBF with #RM/F4  
Neckblock & Finial  
#RM/MB6L Base



## Women's Medium Dress Form

Natural  
#FO/JF6N  
#RM/NBF with #RM/F3  
Neckblock & Finial  
#RM/MB10L Base



## Women's Medium Torso

with Half Legs  
#FO/BV267N-Size 8  
#RM/NBF with #RM/F2  
Neckblock & Finial  
#RM/MB12 Base  
Also available in Size 6  
#FO/BV264N



Comes standard with removable Hang-Wire Loop.



Comes standard with removable Hang-Wire Loop.

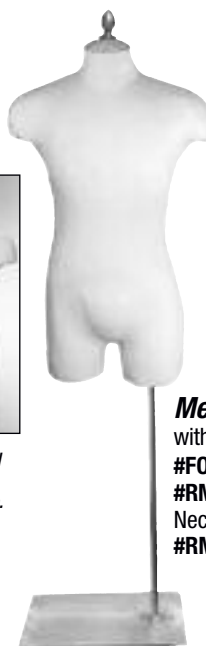

## Men's Torso

with Half legs Natural  
#FO/BV364N  
#RM/NBF with #RM/F6  
Neckblock & Finial  
#RM/MB12 Base

## Men's Medium Shirt Form

Black  
#FO/GH6B  
#RM/NBF-B with #RM/F6  
Neckblock & Finial  
#RM/MB10L Base



## Men's Medium Shirt Form

Natural  
#FO/GH5N  
#FO/MR5N Neckblock  
#FO/PT6N Base



## Women's Blouse Form

Natural  
#FO/JF5N  
#FO/MC5N Neckblock  
#FO/PR5N Base



## Maternity Attachment

6-8 Months.  
attaches to form  
#FTF/PIL68



## Women's Medium Dress Form

Black  
#FO/JF6B  
#RM/NBF with #RM/F4  
Neckblock & Finial  
#RM/MB6L Base



# Metal & Wooden Bases

## Tripod Bases



### Tripod Base

25" H Wood base 42" Overall height  
Natural, Black or White  
#FO/PT6



### Balatar Tripod Base

25" H Wood Base 42" Overall Height  
Natural, Walnut or Mahogany  
#FOBL1



### Cambridge Tripod Base

25" H Wood Base 43" Overall Height  
Natural, Walnut or Mahogany  
#FOCB1



### Somerset Tripod Base

26" H Wood Base 44" Overall Height  
Natural, Walnut or Mahogany  
#FOSM1

## Raw Steel Bases



### Four Leg

Form Base  
#RM/MB5L



### Single Scroll Base

French Form Base  
#RM/MB2L



### Double Scroll Base

French Form Base  
#RM/MB10L



### Triple Scroll Base

French Form Base  
#RM/MB6L



### Flat Base

12" x 16" offset base  
with Long  $\frac{7}{8}$ " Stem  
#RM/MB12



### Children's Base

12" x 14" offset base  
with Long  $\frac{7}{8}$ " Stem  
#RM/MB12-K

## Round Bases



### Round Base

16" High wood base  
33" Overall height  
Natural or White  
#FO/PR5



### Round Base

26" High wood base  
44" Overall height  
White Only  
#FO/PR6



### Barclay Round

26" H Wood Base  
44" Overall Height  
Natural, Mahogany  
or Walnut  
#FOBR1



### Barclay Round

16" H Wood Base  
33" Overall Height  
Natural, Mahogany  
or Walnut  
#FOBR2



### Squared

25" Wood Base  
40" Overall Height  
Natural, Mahogany,  
Walnut or Black  
#FOD/SQF5



### Small Round

11 $\frac{1}{2}$ " H Wood Base  
30" Overall Height  
Natural, Mahogany,  
Walnut or Black  
#FOD/RNDC1



### Large Round

26" H Wood Base  
40" Overall Height  
Natural, Mahogany,  
Walnut or Black  
#FOD/RNDF5



# Neckblocks

## Decorative Neckblocks

Adult Neckblocks with Finial



**RM/NBF**  
with #RM/F1  
Finial, 6¼"



**RM/NBF**  
with #RM/F2  
Finial, 5"



**RM/NBF**  
with #RM/F3  
Finial, 6¼"



**RM/NBF**  
with #RM/F4  
Finial, 4"



**RM/NBF**  
with #RM/F5  
Finial, 2½"



**RM/NBF**  
with #RM/F6  
Finial, 3"



**RM/NBF**  
with #RM/F7  
Finial, 3 ½"



**RM/NBF**  
with #RM/F8  
Finial, 2 ¾"

## Wooden Neckblocks



**Flat Child's Neckblock**  
Fits 6 month form.  
75mm Natural  
#FO/MR2N



**Flat Child's Neckblock**  
Fits 6 month-4 yrs form.  
75mm Natural or White  
#FO/MR3



**Flat Child's Neckblock**  
Fits 6 yrs - 12 yrs form.  
80mm Natural or White  
#FO/MR4



**Flat Adult Neckblock**  
Natural, Black or White  
100mm  
#FO/MR5



**Child's Neckblock**  
Natural or White  
80mm  
#FO/MC1



**Child's Neckblock**  
Natural or White  
90mm  
#FO/MC4



**Child's Neckblock**  
Natural, Black or White  
100mm  
#FO/MC5



**Fairmont Style**  
Natural, Mahogany or Walnut  
99mm  
#FOPNB1



**Cheshire Style**  
Natural, Mahogany or Walnut  
113mm  
#FOPNB2



**Sussex Style**  
Natural, Mahogany or Walnut  
113mm  
#FOPNB3



**Flat Wooden Style**  
113mm Natural  
#FOPNB4



**Flat Metal Cap Style**  
99mm Chrome  
#FOPNB63C

# Children's Forms

## Children's Flexible Forms



10 Years  
48" H  
#FTF/C10



2/3 Years  
29" H  
#FTF/C2



6/12 Months  
22" H  
#FTF/C1



4/5 Years  
33" H  
#FTF/C4



6 Years  
38" H  
#FTF/C6



8 Years  
40" H  
#FTF/C8



**Flex Kid Hat Display**  
With threaded screw.  
Attaches in place of  
Neckblock.  
#FTF/CHD





# Headless Torsos

## Female Torsos

Available in White.  
Base Included.



**#FTF/LT2W** White  
Chest 33 $\frac{1}{2}$ "  
Waist 26"  
Hip 35 $\frac{1}{2}$ "

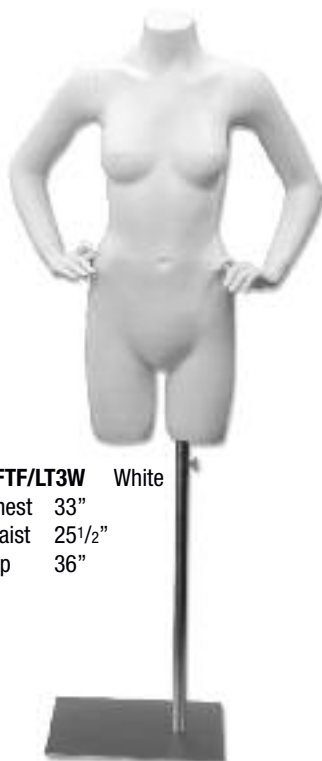

**#FTF/LT3W** White  
Chest 33"  
Waist 25 $\frac{1}{2}$ "  
Hip 36"



**#FTF/LT9W** White  
Chest 33 $\frac{1}{2}$ "  
Waist 26"  
Hip 35 $\frac{1}{2}$ "



**#FTF/LT12W** White  
Chest 33"  
Waist 26"  
Hip 35 $\frac{1}{2}$ "

## Male Torsos

Available in White and Glossy Black.  
Base Included.

**#FTF/MT2GB** Glossy Black  
**#FTF/MT2W** White  
Chest 38"  
Waist 32"  
Hip 38"



**#FTF/MT3GB** Glossy Black  
**#FTF/MT3W** White  
Chest 38 $\frac{1}{2}$ "  
Waist 32 $\frac{1}{2}$ "  
Hip 38"



**#FTF/MT9GB** Glossy Black  
**#FTF/MT9W** White  
Chest 38 $\frac{1}{2}$ "  
Waist 32"  
Hip 38"



# Headless Counter Half Torsos

## Male Torsos

Available in White, Base Included.



**#FTF/MET2W** White  
Chest 38"  
Waist 32"



**#FTF/MET3W** White  
Chest 38 1/2"  
Waist 32 1/2"



**#FTF/MET9W** White  
Chest 38 1/2"  
Waist 32"

## Female Torsos

Available in White and Fleshtone, Base Included.



**#FTF/LET2W** White  
**#FTF/LET2F** Flesh  
Chest 33 1/2"  
Waist 26"



**#FTF/LET3W** White  
**#FTF/LET3F** Flesh  
Chest 33"  
Waist 25 1/2"



**#FTF/LET9W** White  
**#FTF/LET9F** Flesh  
Chest 33 1/2"  
Waist 26"



**#FTF/LET12W** White  
**#FTF/LET12F** Flesh  
Chest 33"  
Waist 26"

# Euro-Headless Mannequins

Available in Silver and Glossy White.

Base Included.



**#FNH/EUF71S** Silver  
**#FNH/EUF71GW** Glossy White  
 Height 64"  
 Chest 34"  
 Waist 24"  
 Hip 35"



**#FNH/EUF72S** Silver  
**#FNH/EUF72GW** Glossy White  
 Height 64"  
 Chest 34 1/2"  
 Waist 24"  
 Hip 34"



**#FNH/EUF73S** Silver  
**#FNH/EUF73GW** Glossy White  
 Height 64"  
 Chest 33"  
 Waist 25"  
 Hip 35"



**#FNH/EUM94S** Silver  
**#FNH/EUM94GW** Glossy White  
 Height 67"  
 Chest 41"  
 Waist 34"  
 Hip 38"



**#FNH/EUM95S** Silver  
**#FNH/EUM95GW** Glossy White  
 Height 67"  
 Chest 40"  
 Waist 33"  
 Hip 38"



**#FNH/EUM96S** Silver  
**#FNH/EUM96GW** Glossy White  
 Height 67"  
 Chest 40"  
 Waist 33"  
 Hip 38"

# Low Cost Headless Mannequins



Height 64 1/2"  
Chest 33 1/2"  
Waist 25 1/4"  
Hip 35"

#FLO/HF15GB Gloss Black  
#FLO/HF15GW Gloss White  
#FLO/HF15GS Gloss Silver  
#FLO/HF15W White



Height 65"  
Chest 33 1/2"  
Waist 25 1/2"  
Hip 34 1/4"

#FLO/HF25GB Gloss Black  
#FLO/HF25GW Gloss White  
#FLO/HF25GS Gloss Silver  
#FLO/HF25W White

**NEW  
ITEMS**



Height 65"  
Chest 34 1/4"  
Waist 25 1/2"  
Hip 36 1/4"

#FLO/HF35GB Gloss Black  
#FLO/HF35GW Gloss White  
#FLO/HF35GS Gloss Silver  
#FLO/HF35W White



Height 65"  
Chest 33"  
Waist 24 3/4"  
Hip 35 1/2"

#FLO/HF45GB Gloss Black  
#FLO/HF45GW Gloss White  
#FLO/HF45GS Gloss Silver  
#FLO/HF45W White

Height 44"  
Chest 34"  
Waist 26"  
Hip 36 1/2"



#FLO/HF55GB Gloss Black  
#FLO/HF55GW Gloss White  
#FLO/HF55GS Gloss Silver  
#FLO/HF55W White



Height 68"  
Chest 41 3/4"  
Waist 31 1/2"  
Hip 38 1/4"

#FLO/HM80W White  
#FLO/HM80GW Gloss White  
#FLO/HM80GS Gloss Silver  
#FLO/HM80GB Gloss Black



Height 65"  
Chest 40 1/4"  
Waist 31 1/2"  
Hip 38 1/4"

#FLO/HM85W White  
#FLO/HM85GW Gloss White  
#FLO/HM85GS Gloss Silver  
#FLO/HM85GB Gloss Black



Height 71"  
Chest 40 1/4"  
Waist 31 1/2"  
Hip 40 1/4"

#FLO/HM90W White  
#FLO/HM90GW Gloss White  
#FLO/HM90GS Gloss Silver  
#FLO/HM90GB Gloss Black

**Available in Fleshtone Only**  
**Chrome Base Included.**



**#FTF/HF1F** Fleshtone  
 Height 65"  
 Chest 33"  
 Waist 25"  
 Hip 34½"



**#FTF/HF2F** Fleshtone  
 Height 64½"  
 Chest 32"  
 Waist 24"  
 Hip 35"



**#FTF/HF3F** Fleshtone  
 Height 62"  
 Chest 32"  
 Waist 24"  
 Hip 35"

**Abstract Mannequins**

**Available in Glossy White.**  
**Chrome Base Included.**



**#F/GW-F03**  
 Height 72"  
 Bust 34"  
 Waist 24"  
 Hip 35"



**#F/GW-F05**  
 Height 71"  
 Bust 34½"  
 Waist 24"  
 Hip 34"



**#F/GW-F11**  
 Height 71"  
 Bust 33"  
 Waist 25"  
 Hip 35"



**#F/GW-M01**  
 Height 73"  
 Chest 41"  
 Waist 34"  
 Hip 38"



**#F/GW-M04**  
 Height 73"  
 Chest 40"  
 Waist 33"  
 Hip 38"

# Abstract Mannequins



Height 75 3/4"  
Chest 41 1/4"  
Waist 31 1/2"  
Hip 38 1/4"

#FLO/AM60GB Gloss Black  
#FLO/AM60GW Gloss White  
#FLO/AM60GS Gloss Silver



Height 74"  
Chest 40 1/4"  
Waist 31 1/2"  
Hip 38 1/4"

#FLO/AM70GB Gloss Black  
#FLO/AM70GW Gloss White  
#FLO/AM70GS Gloss Silver



Height 75"  
Chest 40 1/4"  
Waist 31 1/2"  
Hip 40 1/4"

#FLO/AM80GB Gloss Black  
#FLO/AM80GW Gloss White  
#FLO/AM80GS Gloss Silver



Height 70"  
Chest 33 1/2"  
Waist 25 1/4"  
Hip 35"

#FLO/AF10GB Gloss Black  
#FLO/AF10GW Gloss White  
#FLO/AF10GS Gloss Silver



Height 71 3/4"  
Chest 33 1/2"  
Waist 24 1/2"  
Hip 34 1/4"

#FLO/AF15GB Gloss Black  
#FLO/AF15GW Gloss White  
#FLO/AF15GS Gloss Silver

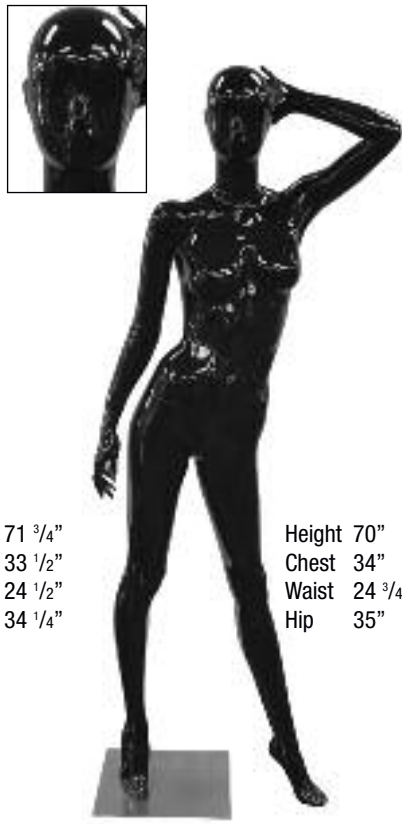

Height 70"  
Chest 34"  
Waist 24 3/4"  
Hip 35"

#FLO/AF20GB Gloss Black  
#FLO/AF20GW Gloss White  
#FLO/AF20GS Gloss Silver

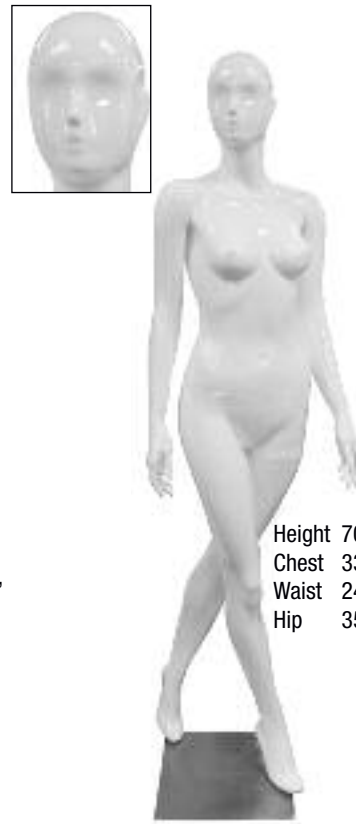

Height 70"  
Chest 33"  
Waist 24 3/4"  
Hip 35 1/2"

#FLO/AF25GB Gloss Black  
#FLO/AF25GW Gloss White  
#FLO/AF25GS Gloss Silver



Height 50"  
Chest 34"  
Waist 26"  
Hip 36 1/2"

#FLO/AF30GB Gloss Black  
#FLO/AF30GW Gloss White  
#FLO/AF30GS Gloss Silver

# Abstract Mannequins

## 5 Different Colors



**NEW  
ITEMS**

**#FTF/EGF-1B** Black  
**#FTF/EGF-1GM** Gun Metal  
**#FTF/EGF-1LB** Light Blue  
**#FTF/EGF-1P** Pink  
**#FTF/EGF-1W** White  
 Height 71"  
 Chest 34"  
 Waist 24.5"  
 Hip 33"

**#FTF/EGF-2B** Black  
**#FTF/EGF-2GM** Gun Metal  
**#FTF/EGF-2LB** Light Blue  
**#FTF/EGF-2P** Pink  
**#FTF/EGF-2W** White  
 Height 71"  
 Chest 34"  
 Waist 24"  
 Hip 34"

**#FTF/EGF-3B** Black  
**#FTF/EGF-3GM** Gun Metal  
**#FTF/EGF-3LB** Light Blue  
**#FTF/EGF-3P** Pink  
**#FTF/EGF-3W** White  
 Height 71"  
 Chest 34.5"  
 Waist 24"  
 Hip 34"

**#FTF/EGM-80B** Black  
**#FTF/EGM-80GM** Gun Metal  
**#FTF/EGM-80LB** Light Blue  
**#FTF/EGM-80W** White  
 Height 73"  
 Chest 40"  
 Waist 31"  
 Hip 34"



**#FTF/EGF-4B** Black  
**#FTF/EGF-4W** White  
 Seated Height 46"  
 Chest 31"  
 Waist 24"

**#FTF/EGM-90B** Black  
**#FTF/EGM-90GM** Gun Metal  
**#FTF/EGM-90LB** Light Blue  
**#FTF/EGM-90W** White  
 Height 75"  
 Chest 37"  
 Waist 31"  
 Hip 35"



# Euro-Mannequins

## 8 Different Poses

Price includes chrome base and choice of wig. Please specify style & color.



**#F/EU-03W**

Height 72"  
Chest 34"  
Waist 24"  
Hip 35"



**#F/EU-04W**

Height 72"  
Chest 33"  
Waist 25"  
Hip 34"



**#F/EU-05W**

Height 71"  
Chest 34 1/2"  
Waist 24"  
Hip 34"



**#F/EU-07W**

Height 72 1/2"  
Chest 33 1/2"  
Waist 25"  
Hip 34"



**#F/EU-11W**

Height 71"  
Chest 33"  
Waist 25"  
Hip 35"

**#F/EU-16W**

Sitting Mannequin

Seated Height 53"  
Chest 36"  
Waist 26"



**#F/EU-17W**

Height 71"  
Chest 34 1/2"  
Waist 24"  
Hip 34"



**#F/EU-76W**

Asian Features  
Height 72"  
Chest 33 1/2"  
Waist 24 1/2"  
Hip 35"





# Euro-Mannequins

## 5 Different Poses

chrome base and choice of wig included. Please specify style & color.



#F/EU-M01W

Height 73"  
Chest 41"  
Waist 34"  
Hip 38"



#F/EU-M02W

Height 73"  
Chest 40"  
Waist 33"  
Hip 38"



#F/EU-M03W

Sitting Mannequin  
Seated Height 55"  
Chest 41"  
Waist 32"



#F/EU-M04W

Height 73"  
Chest 40"  
Waist 33"  
Hip 38"



#F/EU-M56W

Asian Features  
Height 72"  
Chest 41"  
Waist 33"  
Hip 37"

# Voluptuous Female Mannequins



#F/BT-03

Height 69"  
Top Bust 38"  
Under Bust 27"  
Cup D  
Waist 23 1/2"  
Hip 37 1/2"



#F/BT-07

Height 71"  
Cup DD  
Bust 39"  
Waist 25"  
Hip 36 1/2"



#F/BT-10

Height 70 1/2"  
Cup D  
Bust 38"  
Waist 25"  
Hip 37 1/2"



# Low Cost Mannequins

**Chrome Base Included.**

**#FTF/FM1**

Fleshstone with Molded Hair

Height 71"  
Chest 33"  
Waist 25"  
Hip 35"



**#FTF/FM2**

Fleshstone with Molded Hair

**#FTF/FM2BLK**

Black with Molded Hair

Height 70"  
Chest 32"  
Waist 25"  
Hip 35"



**#FTF/FM3**

Fleshstone with Molded Hair

**#FTF/FM3WHT**

White with Molded Hair

**#FTF/FM3BLK**

Black with Molded Hair

Height 69 1/2"  
Chest 32 1/2"  
Waist 24"  
Hip 34 1/2"



**#FTF/FM4**

Fleshstone with Molded Hair

Height 71"  
Chest 33 1/2"  
Waist 24"  
Hip 35"



**#FTF/FM5**

Fleshstone with Molded Hair

**#FTF/FM5WHT**

White with Molded Hair

**#FTF/FM5BLK**

Black with Molded Hair

Height 70"  
Chest 32"  
Waist 25"  
Hip 35"



**#FTF/FLS2**

Plus Size

Fleshstone with Wig

Height 70"  
Chest 41"  
Waist 32 1/2"  
Hip 42 1/2"



**#FTF/MM1**

Fleshstone with Molded Hair

**#FTF/MM1WHT**

White with Molded Hair

Height 73 1/2"  
Chest 40"  
Waist 32"  
Hip 36"



**#FTF/MM2**

Fleshstone with Molded Hair

**#FTF/MM2WHT**

White with Molded Hair

**#FTF/MM2BLK**

Black with Molded Hair

Height 73"  
Chest 40"  
Waist 33"  
Hip 36"



**#FTF/MM3**

Fleshstone with Molded Hair

**#FTF/MM3WHT**

White with Molded Hair

**#FTF/MM3BLK**

Black with Molded Hair

Height 73"  
Chest 40"  
Waist 32"  
Hip 36"



# Low Cost Mannequins

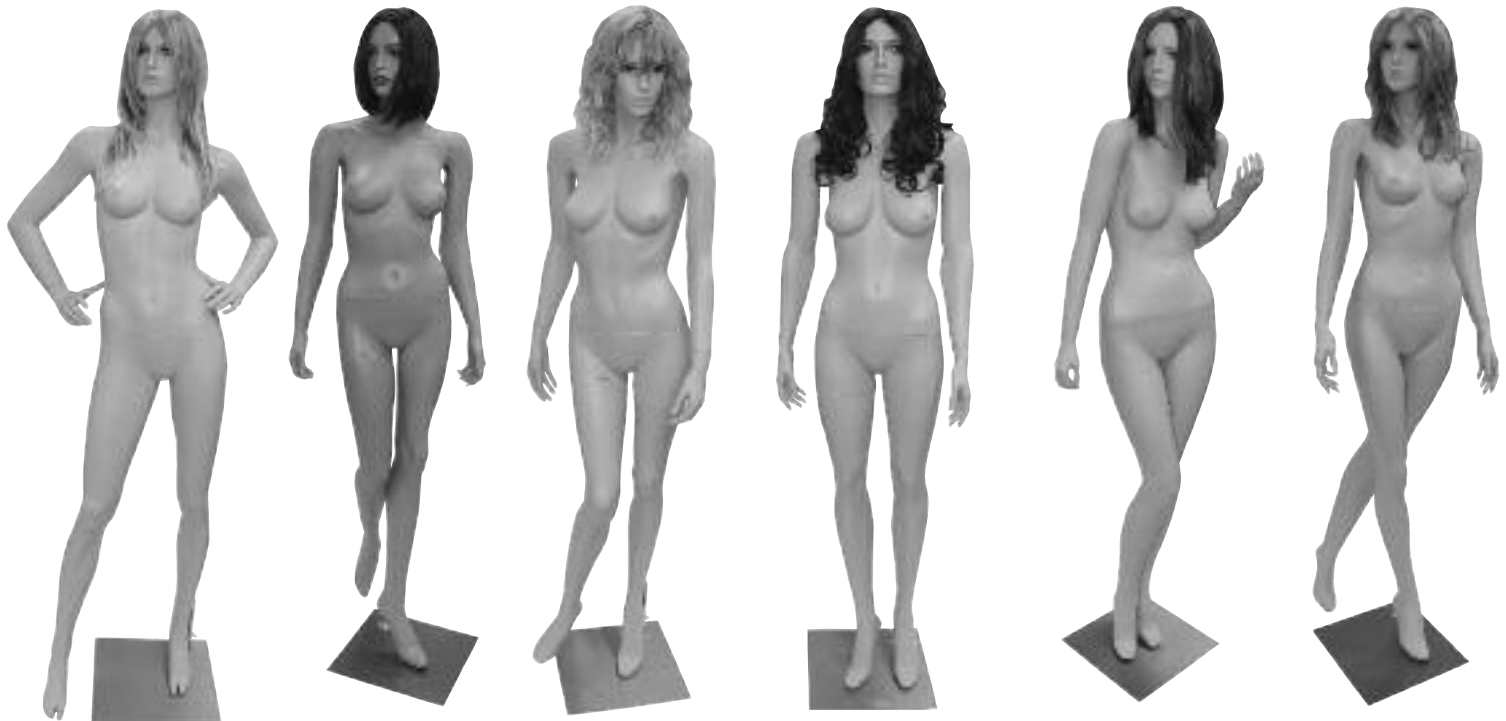

**#FLO/F05WIG**

Height 71<sup>1</sup>/<sub>4</sub>"  
Chest 33<sup>1</sup>/<sub>2</sub>"  
Waist 24<sup>1</sup>/<sub>2</sub>"  
Hip 34<sup>1</sup>/<sub>4</sub>"

**#FLO/F010WIG**

Height 69<sup>3</sup>/<sub>4</sub>"  
Chest 32<sup>3</sup>/<sub>4</sub>"  
Waist 24<sup>3</sup>/<sub>4</sub>"  
Hip 34<sup>3</sup>/<sub>4</sub>"

**#FLO/F015WIG**

Height 69<sup>1</sup>/<sub>4</sub>"  
Chest 32<sup>3</sup>/<sub>4</sub>"  
Waist 24<sup>3</sup>/<sub>4</sub>"  
Hip 35<sup>1</sup>/<sub>2</sub>"

**#FLO/F020WIG**

Height 71<sup>3</sup>/<sub>4</sub>"  
Chest 33<sup>1</sup>/<sub>2</sub>"  
Waist 24<sup>1</sup>/<sub>2</sub>"  
Hip 34<sup>1</sup>/<sub>4</sub>"

**#FLO/F025WIG**

Height 70"  
Chest 34<sup>3</sup>/<sub>4</sub>"  
Waist 23<sup>3</sup>/<sub>4</sub>"  
Hip 35"

**#FLO/F030WIG**

Height 70"  
Chest 33"  
Waist 24<sup>3</sup>/<sub>4</sub>"  
Hip 35<sup>1</sup>/<sub>2</sub>"

# Mannequin Wigs

**Men's Mannequin Wigs** Wigs are available in 3 different colors. For color choice, please specify with the corresponding letter after the item # A: Medium Brown C: Dark Brown D: Blonde

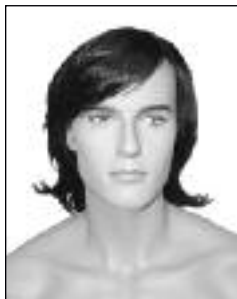

**#F/EUMW1**



**#F/EUMW2**



**#F/EUMW3**

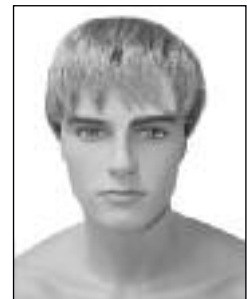

**#F/EUMW4**

**Women's Mannequin Wigs** Wigs are available in 4 different colors. For color choice, please specify with the corresponding letter after the item # A: Blonde B: Dark Blonde C: Medium Brown D: Dark Brown



**#FLO/WIG1**



**#FLO/WIG2**



**#FLO/WIG3**



**#FLO/WIG4**



**#FLO/WIG5**



**#FLO/WIG6**

# Children's Mannequins

Available in Fleshtone and Glossy White.  
Chrome Base Included.

**#FKBH/12A** Fleshtone  
**#FKBH/12WHT** Glossy White  
Height 61"  
Chest 28"  
Waist 25"  
Hip 30"



**#FKBH/6A** Fleshtone  
**#FKBH/6AWHT** Glossy White  
Height 50"  
Chest 25"  
Waist 23"  
Hip 27"



**#FKGH/4A** Fleshtone  
**#FKGH/4AWHT** Glossy White  
Height 44"  
Chest 23"  
Waist 24"  
Hip 27"



**#FKGH/4B** Fleshtone  
**#FKGH/4BWHT** Glossy White  
Height 44"  
Chest 22"  
Waist 20"  
Hip 24"



**#FKGH/6A** Fleshtone  
**#FKGH/6WHT** Glossy White  
Height 50"  
Chest 25"  
Waist 23"  
Hip 26"



**#FKGH/12A** Fleshtone  
**#FKGH/12WHT** Glossy White  
Height 61"  
Chest 29"  
Waist 24"  
Hip 30"



## Children's Headless Mannequins

Available in White. Chrome Base Included.



**#FTF/KNH2**  
Height 34"  
Chest 21"  
Waist 19"  
Hips 21 1/2"



**#FTF/KNH5**  
Height 38 1/2"  
Chest 23"  
Waist 21"  
Hips 24"



**#FTF/KNH6**  
Height 50 1/2"  
Chest 23"  
Waist 22"  
Hips 26"



**#FTF/KNH9**  
Height 52"  
Chest 25"  
Waist 22"  
Hips 28"

# Low Cost Children's Mannequins

Available in Fleshtone.  
Chrome Base Included.

**NEW  
ITEMS**



**#FTF/KB2**  
Height 39"  
Chest 20"  
Waist 21"  
Hips 22 1/2"



**#FTF/KB4**  
Height 44"  
Chest 24"  
Waist 21"  
Hips 23 1/2"



**#FTF/KB6**  
Height 57"  
Chest 25"  
Waist 23"  
Hips 28"



**#FTF/KG3**  
Height 41"  
Chest 21"  
Waist 20"  
Hips 23"



**#FTF/KG5**  
Height 44"  
Chest 23"  
Waist 21 1/2"  
Hips 24 1/2"



**#FTF/KG7**  
Height 50"  
Chest 23"  
Waist 21"  
Hips 25 1/2"



**#FTF/KG9**  
Height 57"  
Chest 23"  
Waist 22"  
Hips 26"

# Knockdown Showcases

Bigger savings can be realized by ordering these in "knockdown" form, saving on expensive crating, packing and shipping charges. The "knockdown" Register Stand & Corner Filler are UPS shippable all other cases must ship common carrier.



### Wallcase

Item#	Assembled	
#JDW/UC4	48"W x 18"D x 78"H	
Available in White, Black and Maple		
#JDW/UC6	70"W x 18"D x 78"H	
Available in Black and Maple		



### Ledgetop Counter with Recessed Top

Available in Black, Maple, Cherry, White with Black trim and now White with White trim

Item#	Size	
#JDW/LT4	48"L x 22"D x 42"H	
#JDW/LT6	70"L x 22"D x 42"H	

**Selected White items now come with your chose of White or Black trim**



### Full Vision Showcase

Available in Black, Maple, Cherry, White with Black trim and now White with White trim

Item#	Size	
#JDW/SC4	48"L x 18"D x 38"H	
#JDW/SC6	70"L x 18"D x 38"H	



### Flat Top Counter

Available in Black, Maple, Cherry, White with Black trim and now White with White trim

Item#	Size	
#JDW/WC4	48"L x 20"D x 38"H	
#JDW/WC6	70"L x 20"D x 38"H	



### Corner Filler

Available in Black, Maple, Cherry, White with Black trim and now White with White trim

Item #	Assembled	
#JDW/FILL	18"L x 18"D x 38"H	



### Jewelry Showcase

Available in Black, Maple and Cherry

Item	Size	
#JDW/JC6	70"L x 18"D x 38"H	



#JL4LED  
4' Showcase Light

#JL6LED  
6' Showcase Light



### Recess Top Cash Register Stand

Available in Black, Maple, Cherry, White with Black trim and now White with White trim

Item#	Size	
#JDW/RS	24"L x 18"D x 38"H	

# Ledgetop Counters with Slatwall Front



**NEW  
ITEMS**



## 4' Ledgetop Counter with Recessed Top and Slatwall Front

- #JDW/LT4B-SW 48"L x 22"D x 42"H Black
- #JDW/LT4C-SW 48"L x 22"D x 42"H Cherry
- #JDW/LT4M-SW 48"L x 22"D x 42"H Maple
- #JDW/LT4W-SW 48"L x 22"D x 42"H White with white trim

## 6' Ledgetop Counter with Recessed Top and Slatwall Front

- #JDW/LT6B-SW 70"L x 22"D x 42"H Black
- #JDW/LT6C-SW 70"L x 22"D x 42"H Cherry
- #JDW/LT6M-SW 70"L x 22"D x 42"H Maple
- #JDW/LT6W-SW 70"L x 22"D x 42"H White with white trim

# Ledgetop Counters with Showcase Front



**NEW  
ITEMS**

## 6' Ledgetop Counter with Recessed Top and Showcase Front

- #JDW/LT6B-CSE 70"L x 22"D x 42"H Black
- #JDW/LT6C-CSE 70"L x 22"D x 42"H Cherry
- #JDW/LT6M-CSE 70"L x 22"D x 42"H Maple

# Bellissimo Series Showcases



## Full Vision Showcases

With Lock (except Corner Case Filler)

- #JBEL4 38"H x 20"D x 48"L
- #JBEL5 38"H x 20"D x 60"L
- #JBEL6 38"H x 20"D x 70"L
- #JBELC Rear Access Corner
- #JBELCCF Corner Case Filler
- #JBELCCF/FO Corner Case Filler-Front opening



## Corner Filler

Maple LPL. Front Opening

- #JBELCCF/M 38"H x 20"D x 20"L
- #JBELCCFM/FO 38"H x 20"D x 20"L



## Half Vision Showcases

With Lock (except Corner Case Filler)

- #JBEL/HV4 38"H x 20"D x 48"L
- #JBEL/HV5 38"H x 20"D x 60"L
- #JBEL/HV6 38"H x 20"D x 70"L
- #JBEL/HVC Rear Access Corner
- #JBELCCF Corner Case Filler



## Jewelry Showcases

With Lock (except Corner Case Filler)

- #JBEL/JC4 38"H x 20"D x 48"L
- #JBEL/JC5 38"H x 20"D x 60"L
- #JBEL/JC6 38"H x 20"D x 70"L
- #JBEL/JCC Rear Access Corner
- #JBELCCF Corner Case Filler



## Wallcases

With Lock & Light

- #JBELWC4 74"H x 20"D x 48"L
- #JBELWC5 74"H x 20"D x 60"L
- #JBELWC6 74"H x 20"D x 70"L

## Showcase & Wallcase Options

- #JBEL/A1 Lights
- #JBEL/A4 Locks
- #JBEL/A5 Mirrored Doors
- #JBEL/A6 Front Opening Doors
- #JBEL/A7 Storage Door Upcharge
- #JBEL/A8 Locks on Storage Doors
- #JBEL/A9 Wallcase - Mirrored Back
- #JBEL/A5 Full Vision Cases - Mirrored Back
- #JBEL/A11 Wallcase - Glass Back
- #JBEL/A12 Powdercoat Showcase Frame

## Showcase & Wallcase Laminate Upcharges\*

### #JBEL/A50 Exterior Base Only

Wallcase, Full Vision & Rear Access Corner Case  
Full Vision Corner Case Filler  
Half Vision, Jewelry & Rear Access Corner Case  
Half Vision & Jewelry Corner Case Filler

### #JBEL/A50 Interior Base Deck Only

Wallcase, Full Vision, Half Vision,  
Jewelry & Rear Access Corner Case  
Full Vision, Half Vision & Jewelry Corner Case Filler

\*standard high pressure laminates only, other laminates available by quote.



# Bellissimo Series Showcases

These distinctive and elegant designed showcases will give a high visibility from all sides, maximizing the selling display area per square footage. All of the glass is safety tempered, giving the showcase added security and safety against unwanted accidents. Prices shown for Maple LPL



**Tower Showcase**  
Maple LPL. Front opening only  
79 1/2"H x 20"D x 20"L  
#JBELWC2/M



**Corner Tower**  
Maple LPL. Front opening only  
79 1/2"H x 20"D x 20"L  
#JBELWCC/M

## Tower Laminate Upcharges

- #JBEL/A50 Aluminum Low Pressure Laminate
- #JBEL/A50 Standard High Pressure Laminate

## Tower Options

- #JBEL/A25 Canopy Lights\*
- #JBEL/A12 Powdercoat Frame

\*canopy lights wired for canopy power only.  
micro side lights wired for base power only.

## Allegro Counter Cases



Item #	Size
#JALE/1	8"D x 16"W x 18"H
#JALE/7	8"D x 16"W x 24"H
#JALE/11	12"D x 16"W x 24"H

## Special Order

#JALE/2	10"D x 14"W x 18"H
#JALE/3	10"D x 16"W x 18"H
#JALE/4	12"D x 12"W x 18"H
#JALE/5	12"D x 16"W x 18"H
#JALE/6	12"D x 18"W x 18"H
#JALE/8	10"D x 14"W x 24"H
#JALE/9	12"D x 12"W x 24"H
#JALE/10	10"D x 16"W x 24"H

## Aluminum Counter Showcases with Black and Silver Gloss Finish



#JF/1301B Black  
#JF/1301S Silver  
24"L x 12"D x 18"H



#JF/1302B Black  
#JF/1302S Silver  
30"L x 18"D x 9"H



#JF/1303B Black  
#JF/1303S Silver  
14"L x 12"D x 27"H

# Frameless Glass Showcases

These cases are packed in "knockdown" form, saving on expensive crating, packing and shipping charges.  
All cases must ship common carrier.



**Narrow Tower Case**  
With Lock  
20"L x 20" D x 72" H  
#JFC/TC20-H



**Counter Case**  
With Lock  
13"L x 13" D x 24" H  
#JFC/CC24B



**Wide Tower Case**  
With Lock  
36"L x 16" D x 80" H  
#JFC/TC36

**Jewelry Case**  
With Lock  
36"L x 20" D x 38" H  
#JFC/JC36B



**Half Vision Case**  
With Lock  
36"L x 20" D x 38" H  
#JFC/HV36B



**NEW  
ITEMS**

## Aluminum Counter Showcases with Black and SilverGloss Finish



#JF/1301B Black  
#JF/1301S Silver  
24"L x 12"D x 18"H



#JF/1302B Black  
#JF/1302S Silver  
30"L x 18"D x 9"H



#JF/1303B Black  
#JF/1303S Silver  
14"L x 12"D x 27"H

**Die Cut Handle Frosted Bags**



**See page 21**

**Soft Loop Handle Frosted Bags**



**See pages 22 to 23**

**Precious Metals Shopping Bags**



**Natural Pinstripe Tint Shopping Bags**



**Sheer Bags**

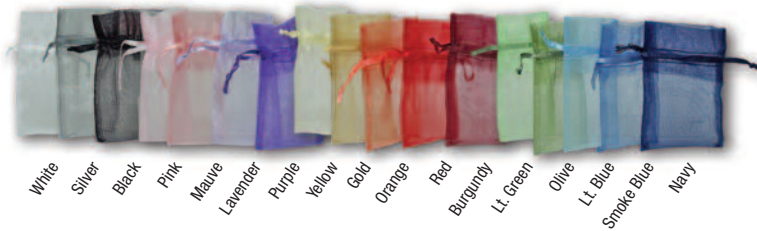

**See page 51**

**Velveteen Bags**



**Brown Kraft Tint Shopping Bags**



**White & Natural Shopping Bags**



**Solid Tissue Colors**

**See page 36**



**Metallic Tissue**

**Leopard & Zebra Print Shopping Bags**



**Printed Tissue Paper**



**Leopard & Zebra Print Jewelry Boxes**



**See pages 35**



**See page 116**

**See page 125**

**See page 114**



**See page 123**

**See page 64**

